



OKM



USER MANUAL

TRANSPORTATION & STORAGE

SCOPE OF DELIVERY

ASSEMBLY

GETTING STARTED

OPERATIONS

MAINTENANCE

TROUBLESHOOTING

DISPOSAL

TECHNICAL SPECIFICATIONS

REPS & WARRANTIES

OKM[®] eXp 5500 Professional

Detector for Treasure Hunting and Archaeology

MODEL: X55-A01

© 2024 OKM GmbH. All Rights Reserved.

U.S. Edition | English 
Version 1.0 | November 2024



Do not drink any alcohol or take any drugs before or during the operation of the device and follow the instructions carefully!



NOTICE

Read all instructions first before commencing the assembly and usage!

OKM GmbH
Julius-Zinkeisen-Str. 7
04600 Altenburg
Germany

Phone: +49 3447 499 3000
Website: www.okmdetectors.com

No part of this document may be reproduced in any form (by printing, photocopying or other means) or processed, duplicated or circulated electronically without prior written approval of OKM GmbH.

Copyright © 2024 OKM GmbH. All rights reserved.

NOTICE

The search for historical and archaeological artifacts and structures may be regulated in different ways from state to state. Searching with a detector may require approvals and permissions from landowners, public agencies and/or government authorities.

With the purchase of the OKM detector you DO NOT automatically receive a detection permit or excavation permit! Consult the authorities responsible for your search project and/or area for information on required permits.

DISCLAIMER

The metal detector referred to in this manual has been specifically designed and manufactured as a high-quality ground scanner and is recommended for treasure hunting in non-hazardous environments. This metal detector has not been designed as a mine detector.



NOTICE

All artifacts found on public lands are protected by state and federal laws. It is illegal to collect artifacts on public lands. Artifacts include anything made or used by humans including arrowheads and flakes, pottery, basketry, rock art, bottles, coins, metal pieces, and even old cans. Ancient objects that are found on private land are legal for individuals to collect with written permission from the landowner and legal for individuals to own under the Native American Graves Protection and Repatriation Act of 1990 (NAGPRA).

However, these objects could be subject to a civil claim of superior title by a tribe. Other requirements depend on the state. If you are interested in collecting or metal detecting on private property, contact your State Historic Preservation Office for more information.

Before collecting minerals found, familiarize yourself with the rules stated on the Bureau of Land Management Website for your State.

TABLE OF CONTENTS

1 TRANSPORTATION AND STORAGE	5	5 OPERATIONS	25
1.1 AVOID EXTREME TEMPERATURES AND MOISTURE.....	5	5.1 PACEMAKERS.....	25
1.2 CHECK BATTERY STATUS REGULARLY.....	5	5.2 CAUTION DURING EXCAVATION.....	25
2 SCOPE OF DELIVERY AND CONTROL ELEMENTS	7	5.3 OPERATING MODES.....	25
2.1 CONTROL UNIT.....	8	5.4 MAGNETOMETER.....	26
2.2 PENTASENSE SYSTEM.....	9	5.5 3D GROUND SCAN.....	28
2.3 PENTASENSE ROD.....	9	5.6 FILE EXPLORER.....	36
2.4 PENTACOIL (VLF COIL).....	10	5.7 VLF METAL DETECTION.....	40
2.5 TELESCOPIC ROD.....	10	6 MAINTENANCE	45
2.6 CHARGER AND TRAVEL ADAPTERS.....	10	6.1 CHECK AND CLEAN CONTROL UNIT AND PROBES.....	45
2.7 BLUETOOTH HEADPHONES.....	10	6.2 REPLACE INTERNAL BATTERY.....	45
2.8 PROTECTOR CASE.....	10	6.3 FIRMWARE UPDATES.....	46
3 ASSEMBLY	13	6.4 REGISTER/VERIFY DETECTOR.....	48
3.1 NECESSARY TOOLS.....	13	6.5 MAINTENANCE AND REPAIR BY OKM.....	48
3.2 PENTASENSE SYSTEM.....	13	7 TROUBLESHOOTING	51
3.3 PENTASENSE ROD.....	14	8 DISPOSAL	61
3.4 BACKSTRAP + CONTROL UNIT.....	14	9 TECHNICAL SPECIFICATIONS	63
3.5 PENTACOIL + TELESCOPIC ROD.....	15	9.1 CONTROL UNIT.....	63
4 GETTING STARTED	17	9.2 SUPER SENSOR.....	63
4.1 INTERNAL BATTERY.....	17	9.3 ENHANCER.....	63
4.2 SWITCH ON THE CONTROL UNIT.....	18	9.4 PENTACOIL.....	63
4.3 MAIN MENU AND NAVIGATION.....	18	9.5 PENTASENSE ROD.....	63
4.4 WELCOME DIALOG.....	18	10 REPS & WARRANTIES	64
4.5 SETTINGS.....	19	10.1 ACKNOWLEDGEMENTS, REPRESENTATIONS & WARRANTIES.....	64
4.6 PAIR/CONNECT BLUETOOTH HEADPHONES.....	22	10.2 INDEMNIFICATION.....	65
		10.3 LIMITATION OF LIABILITY.....	65
		10.4 SERVICE & SUPPORT.....	65

TRANSPORTATION & STORAGE

1 TRANSPORTATION AND STORAGE

Protect your detector and accessories by storing them in the Protector Case in a cool, dry place (50 to 75°F | 10 to 25°C). Unplug the probe from the Control Unit and power off the Control Unit before packing the device and its accessories into the case.

Use the Protector Case for the intended purpose only. Keep away from children!



When shipping, use the original cardboard box or similar heavy-duty container and provide sufficient padding around all parts.

1.1 AVOID EXTREME TEMPERATURES AND MOISTURE



Protect your device from extreme temperatures as well as dust and moisture during transportation and storage.

1.2 CHECK BATTERY STATUS REGULARLY

Check the detector regularly if it is not used for a long time. When storing the eXp 5500 for long periods of time, avoid completely discharging of the battery. Instead, recharge the battery at least every 3 months and up to approx. 90% of the maximum charge capacity.

SCOPE OF DELIVERY

2 SCOPE OF DELIVERY AND CONTROL ELEMENTS

I	Super Sensor	✓
II	Windows Notebook with <i>Visualizer 3D Studio</i>	✓
III	Protector Case	✓
IV	PentaSense Rod	✓
V	Telescopic Rod	✓
VI	PentaCoil (VLF Coil)	✓
VII	4 Protective Caps	✓
VIII	4 Enhancers	✓
IX	Control Unit	✓
X	Backstrap	✓
XI	USB Flash Drive	✓
XII	Open-Ear Headphones	✓
XIII	Charger and Travel Adapters	✓
XIV	USB-C Cable	✓
XV	Power Pack	✓



2.1 CONTROL UNIT

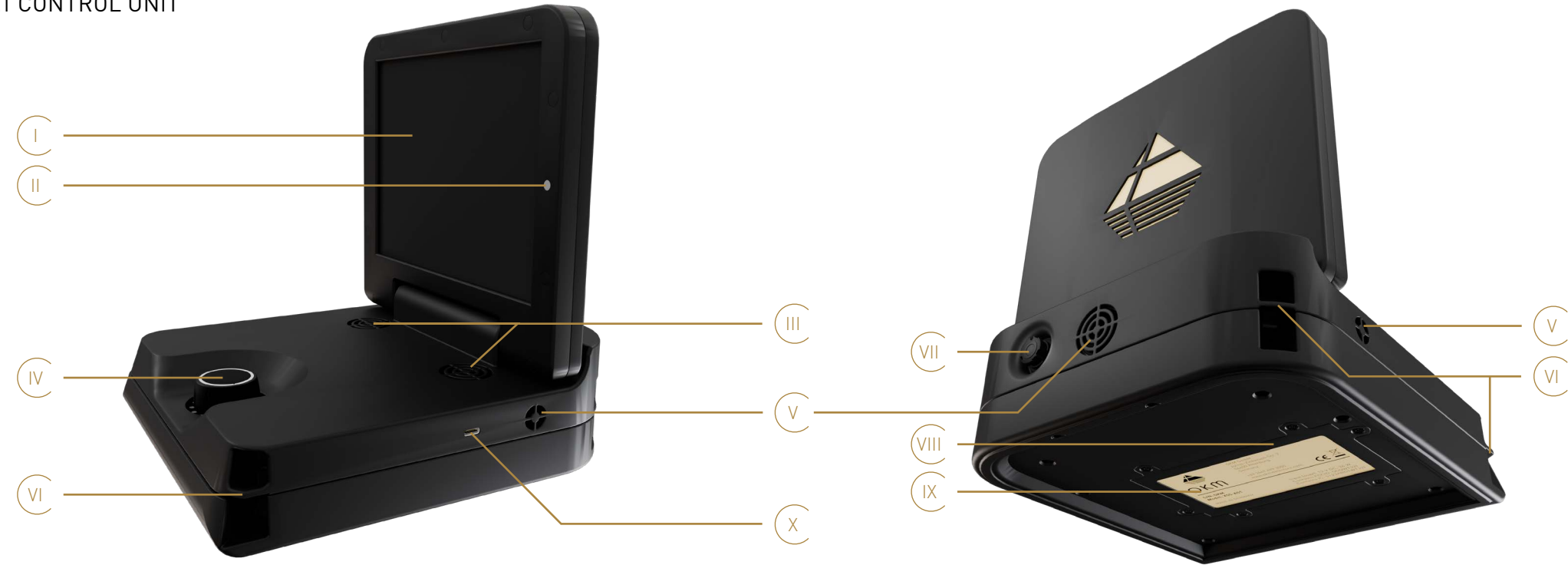

- I Touchscreen – see [4.3 Main Menu and Navigation](#) on page 18.
- II Brightness sensor – see [4.5.1 Display](#) on page 19. **Please do not cover the brightness sensor.**
- III Speakers – see [4.5.2 Sound](#) on page 19.
- IV Knob with LED ring to show active Transfer Mode, Bluetooth states – see [4.6 Pair/Connect Bluetooth Headphones](#) on page 22 – and charging states – see [4.1.3 Battery Level and Charging State](#) on page 17.
- V Ventilation openings to ensure adequate cooling of the internal processing units. **Do never cover the ventilation openings!**
- VI Eyelets for carabiners (snap hooks) – see [3.4 Backstrap + Control Unit](#) on page 14.
- VII Probe socket
- VIII Battery compartment – see [6.2 Replace Internal Battery](#) on page 45.
- IX Label with device information like serial number and model number.
- X USB-C socket for file transfer – see [5.6.2 Transfer Files](#) on page 38, and battery charging – see [4.1.2 Charge Battery](#) on page 17.

2.2 PENTASENSE SYSTEM

The PentaSense System comprises the Super Sensor with LED Orbit and 4 sensor modules, so-called *Enhancers*. These can be plugged into any of the Super Sensor sockets. The PentaSense system offers 4 possible combinations – suitable for different measuring environments. For more information and correct assembly see [3.2 PentaSense System](#) on page 13.

An arrow at the top of the Super Sensor indicates the direction of measurement. The LED Orbit at the lower end of the Super Sensor displays scanning states and results.

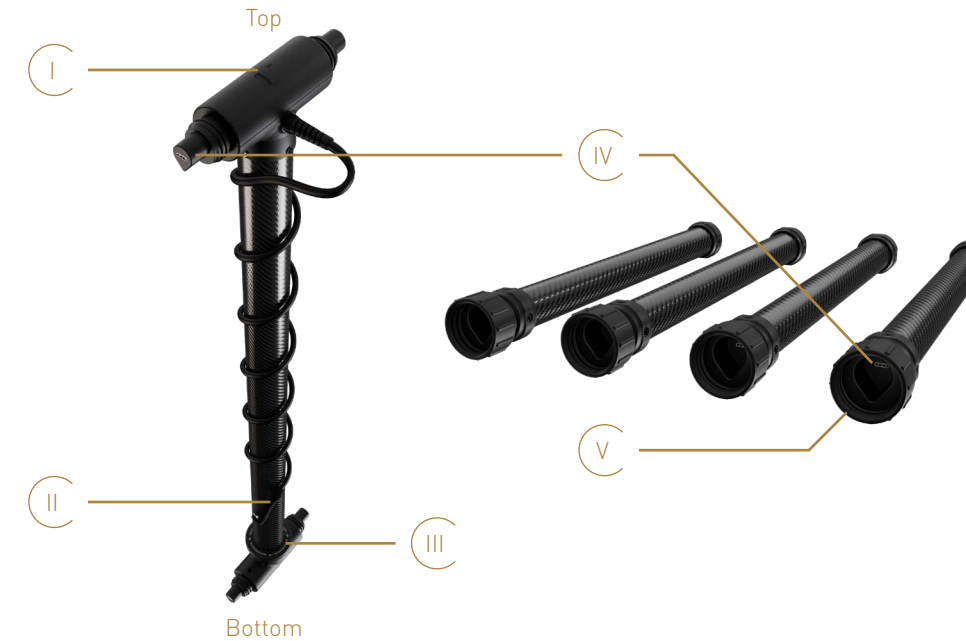

- I Super Sensor with arrow on top of the probe
- II Probe plug
- III LED Orbit (12 LEDs)
- IV Plugs/Sockets (4x Super Sensor + 4x Enhancers)
- V Enhancer union nuts (4x)

Depending on how many Enhancers are connected to the Super Sensor, we recommend using the Protective Caps to protect the open plugs/sockets from moisture or dirt.

2.3 PENTASENSE ROD

The PentaSense System can either be carried by hand or by using the PentaSense Rod. For correct assembly see [3.3 PentaSense Rod](#) on page 14.

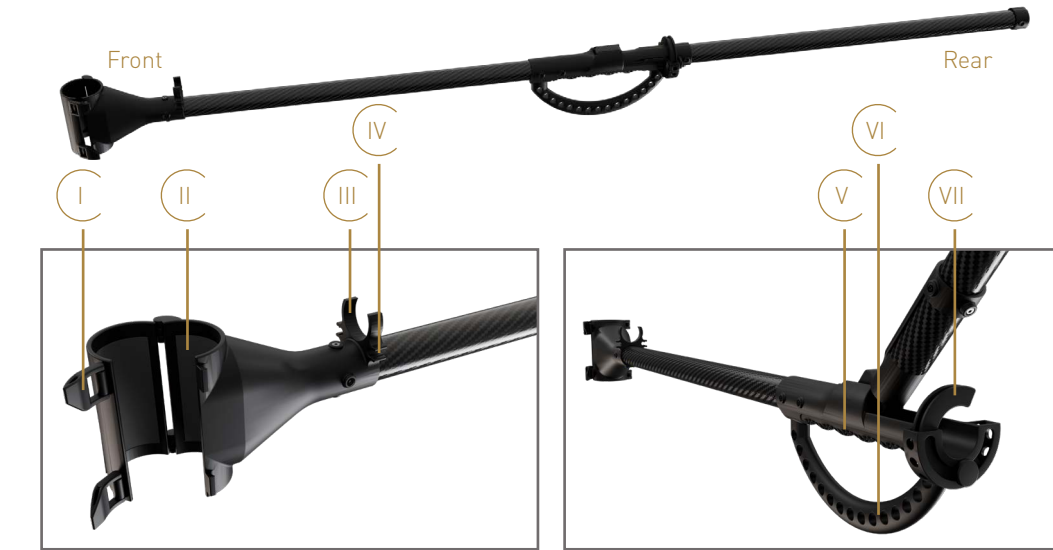

- I Probe mount clips (2x)
- II Probe mount with non-slip skin inside
- III Clamp for rear rod arm during transportation
- IV Clamp for probe cable during measurement
- V Handle
- VI Bracing | **Do not use this bracing as handle!**
- VII Locking ring

ASSEMBLY

3 ASSEMBLY



3.1 NECESSARY TOOLS

No additional tools are required to assemble the OKM eXp 5500 Professional.

Do not open the device and/or accessories. There are no end user serviceable parts inside. To replace the internal battery, see [6.2 Replace Internal Battery on page 45](#).

Probes shall always be attached in the prescribed way matching the probe socket.

	NOTICE
	Make sure the probe sockets and plugs are clean before assembly!

3.2 PENTASENSE SYSTEM

3.2.1 Connect Enhancers

The sensor modules are identical and therefore interchangeable.



1. Unscrew the Protective Caps from the Super Sensor.

2. Attach the Enhancers. Secure the modules with the union nuts.

3.2.2 Enhancer Configurations

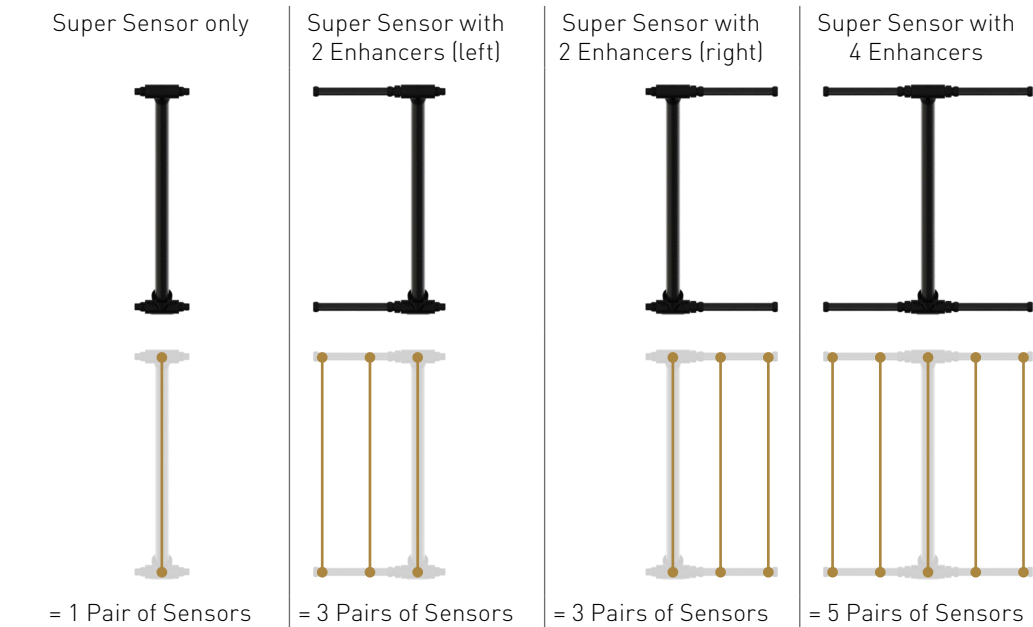

If you attach 2 Enhancers, they must both be plugged in at the bottom and top on the same side (right OR left). The pairs of sensors must be complete in order to work properly.

3.3 PENTASENSE ROD



1 Unfold the PentaSense Rod.



2 Snap the locking ring into place.



3 Unlock the probe mount clips and insert the Super Sensor in a comfortable height.



4 Lock the probe mount clips.

When inserting the probe, make sure the probe is oriented correctly: The arrow is up and must point in the scanning direction.

Alternatively, the Super Sensor/PentaSense System can be carried in the hand without using the PentaSense Rod. Make sure there is sufficient distance between the Control Unit and the sensors.



3.4 BACKSTRAP + CONTROL UNIT

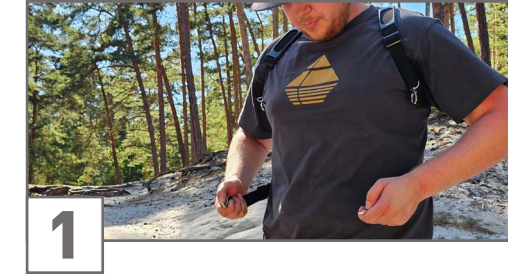

1 Put on the backstrap: Place the upper straps around your shoulders like a backpack.

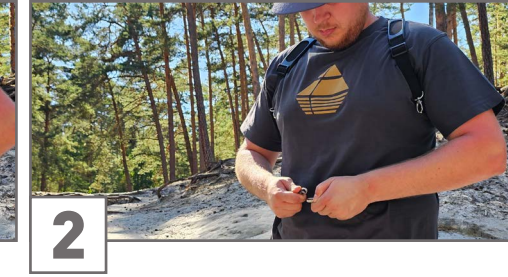

2 For easier attachment, we recommend temporarily linking the carabiners of the lower straps.

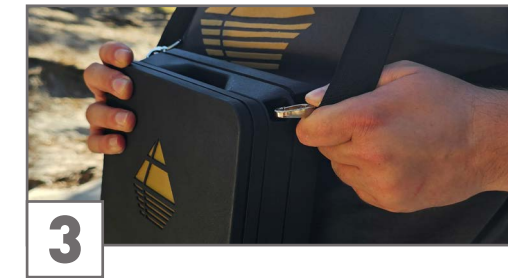

3 Attach the Control Unit to the upper carabiners.



4 Lift the Control Unit to see the socket at the rear and plug in the probe.



5 Align the white markings, push the plug into the socket, and rotate the plug cap clockwise to fix the plug.

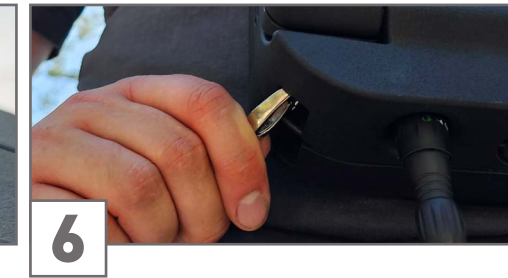

6 Attach the Control Unit to the lower carabiners.

3.5 PENTACOIL + TELESCOPIC ROD



1 Unscrew the mounting screw from the coil mount at the Telescopic Rod. Make sure the rubber washers are seated next to the shaft before attaching the PentaCoil.

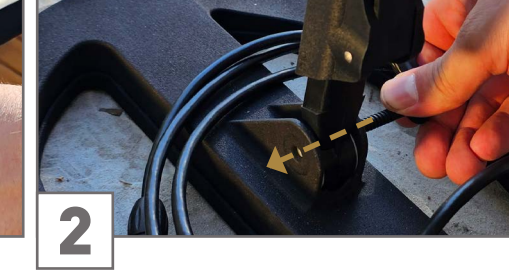

2 Insert the coil mount of the Telescopic Rod into the shaft adapter of the PentaCoil. Fix it with the mounting screw and tighten it so that the coil does not move.



3 Use the locking levers to loosen the single segments of the Telescopic Rod.



4 Adjust the Telescopic Rod to your body height to allow for more comfort while working with the detector. Lock the levers to fix the height.

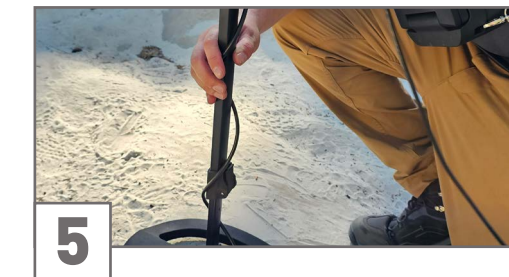

5 Wrap the cable tightly around the Telescopic Rod to avoid false signals while detecting.



6 Plug the probe into the Control Unit – see 3.4 Backstrap + Control Unit on page 14.

4.2 SWITCH ON THE CONTROL UNIT

Unfold the display. Press and hold the Knob for 5s to switch on the Control Unit. As soon as the Control Unit is booting, golden LEDs circle around the Knob.

It can take several seconds to fully boot the Control Unit. Wait until the Control Unit is ready.

4.3 MAIN MENU AND NAVIGATION

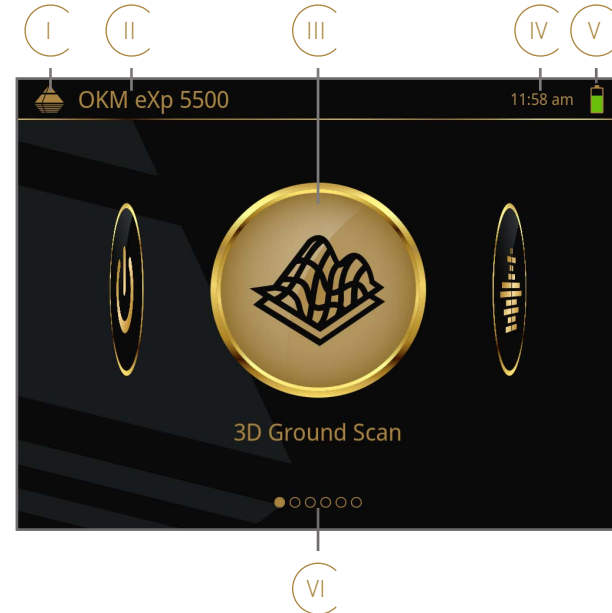

- I Screen icon shows the active menu/option.
- II Headline indicates the active menu/option.
- III Option: Tap to open the operating mode/option.
- IV Time and time format can be changed in Settings – see [4.5 Settings on page 19](#).
- V Battery level indicates the current battery level – see [4.1.3 Battery Level and Charging State on page 17](#).
- VI Page indicator shows your current position in the Main Menu.

The application can be controlled by:

1. Touchscreen: Tap on the item to select/open the preferred option.
2. Knob: Rotate to move the selection frame from one item to another. Push the Knob to select/open the preferred option.

4.4 WELCOME DIALOG

Usually, a Welcome Dialog is displayed the first time you start the Control Unit.



We recommend to personalize your regional settings first – see [4.5.4 Regional Preferences on page 20](#). To proceed, confirm with or cancel with . Afterwards, this dialog will not appear again.

The dialog can be reactivated in Settings > Reset:

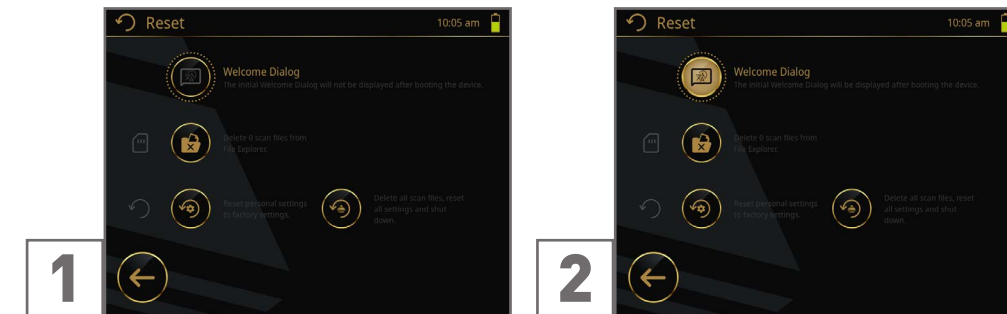

1 Tap on Welcome Dialog to (de)activate it.

2 If activated, this dialog will be shown the next time the Control Unit is started.

Also, this option will be reactivated as soon as the Control Unit is reset to factory defaults – see [4.5.5 Reset on page 21](#).

4.5 SETTINGS

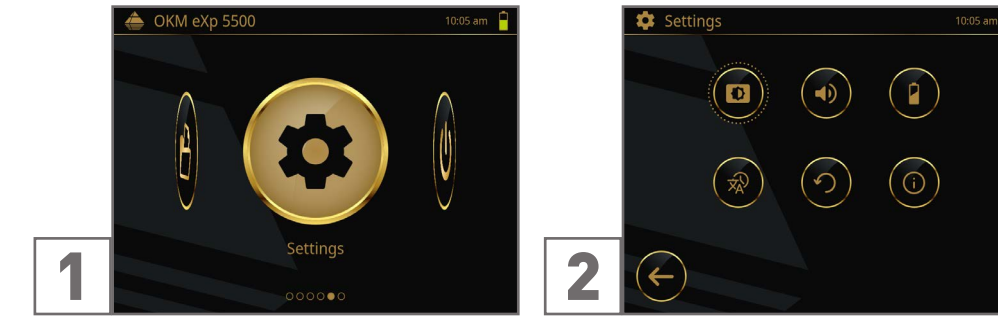

1 Swipe to the left or right to browse through the Main Menu and select Settings.

2 Open the preferred Settings option.

	Display	see 4.5.1 Display on page 19
	Sound	see 4.5.2 Sound on page 19
	Battery	see 4.5.3 Battery on page 20
	Regional Preferences	see 4.5.4 Regional Preferences on page 20
	Reset	see 4.5.5 Reset on page 21
	Information	see 4.5.6 Information on page 21

4.5.1 Display

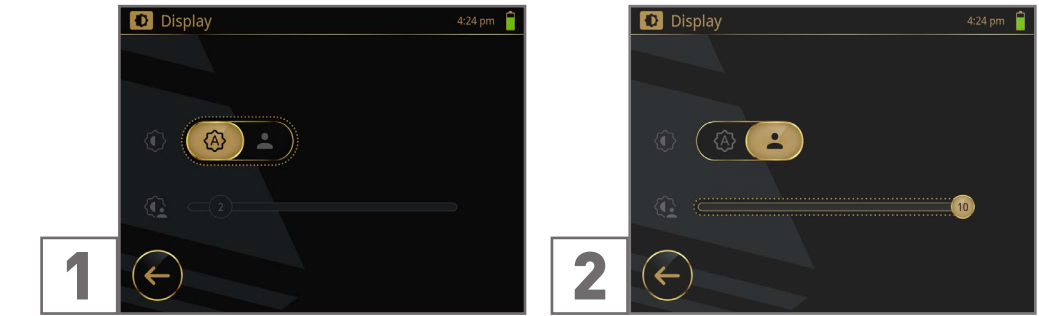

1 Select Automatic Brightness to allow the screen to adjust automatically to the ambient light.

2 Select Manual Brightness and move the slider to adjust the screen brightness individually.

4.5.2 Sound

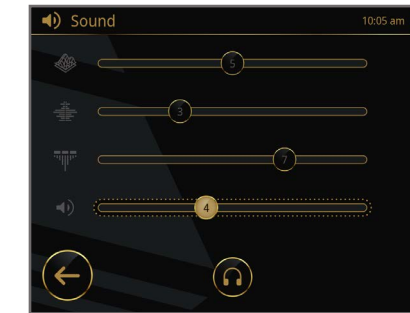

To avoid attracting attention you may decrease the volume or use Bluetooth headphones.

Tap on to proceed with pairing/connecting Bluetooth headphones – see [4.6 Pair/Connect Bluetooth Headphones on page 22](#).

- Move the first slider to adjust the **3D Ground Scan pulses volume** individually.
- Move the second slider to adjust the **Magnetometer feedback volume** individually.
- Move the third slider to adjust the **VLF Metal Detection feedback volume** individually.
- Move the fourth slider to adjust the **general volume** individually.

4.5.3 Battery

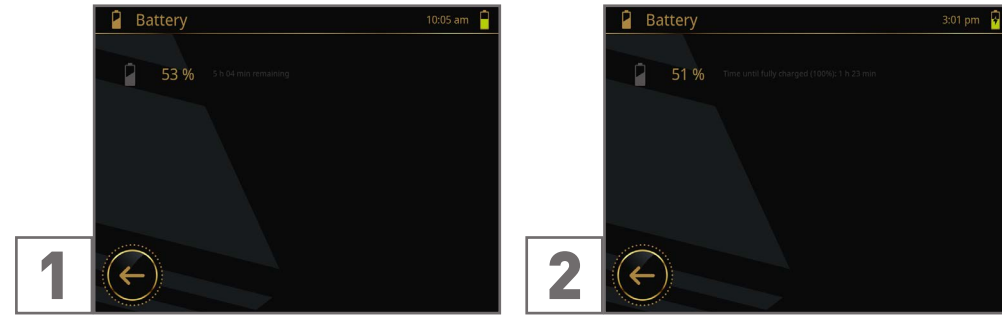

1 If no charger is connected, this screen shows the remaining operating time and the current battery level.

2 If the charger is connected, this screen shows the remaining charging time until the battery is fully charged and the current battery level.

4.5.4 Regional Preferences

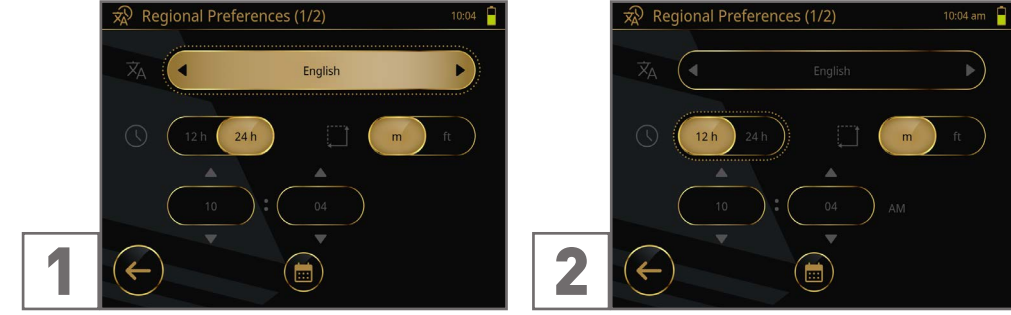

1 Use the arrows (left/right) to loop through the available languages.

2 Tap on the toggle to select your preferred time format (12h | 24h).

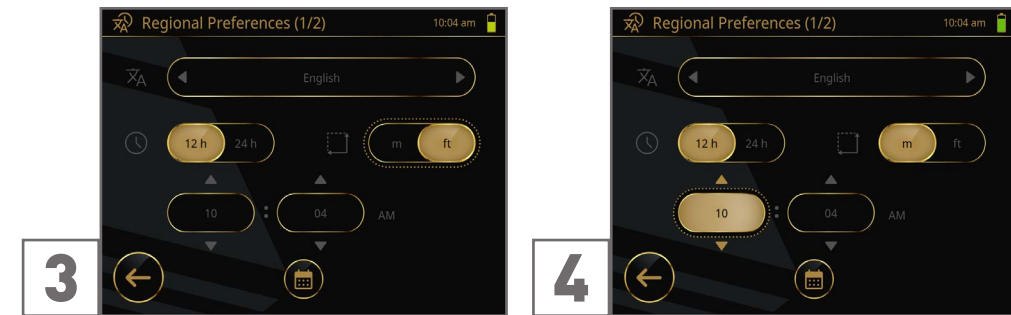

3 Tap on the toggle to select your preferred length unit (imperial *ft* | metric *m*).

4 Use the arrows (up/down) to set the time (hh:mm) according to the selected format.

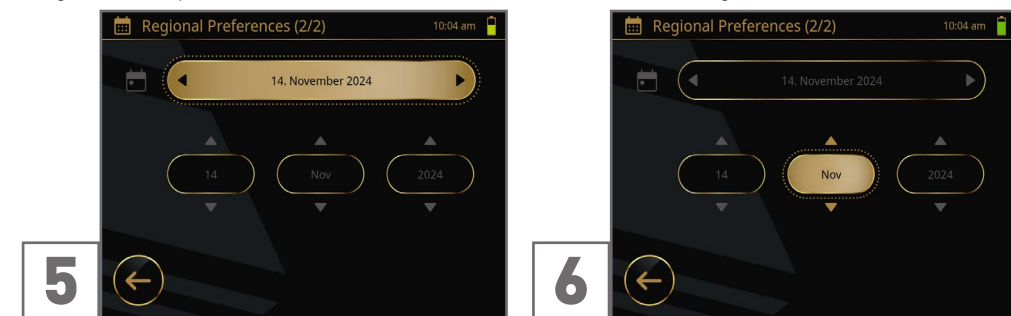

5 Tap on the calendar icon to set the date. Use the arrows (left/right) to select your preferred date format.

6 Use the arrows (up/down) to set the day, month and year according to the selected format.

4.5.5 Reset

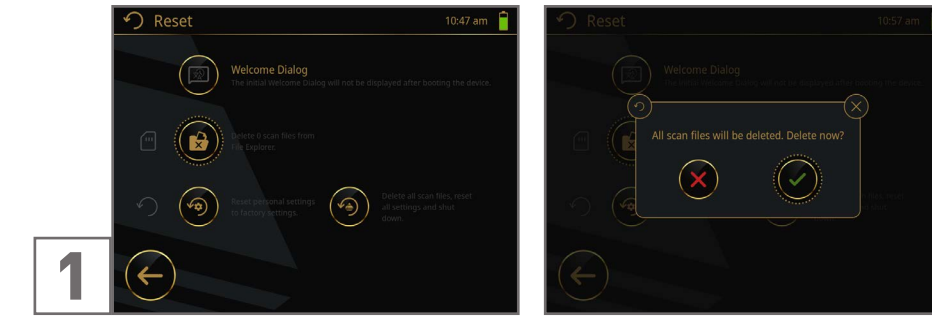

1 Tap on the button to delete all scan files from the File Explorer.

You must confirm the action again before it is executed.

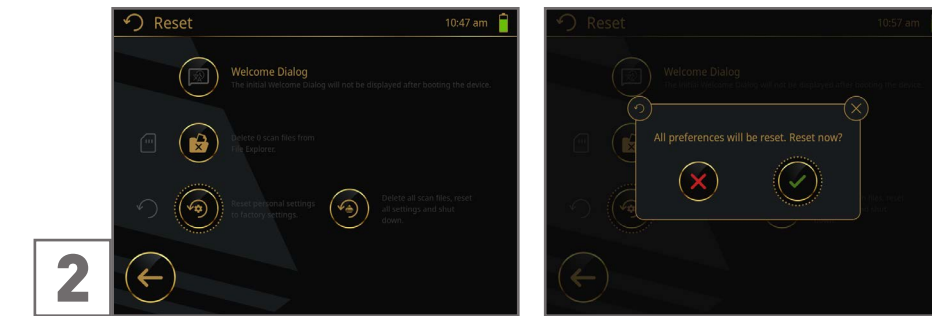

2 Tap on the button to reset all preferences to default settings.

You must confirm the action again before it is executed.

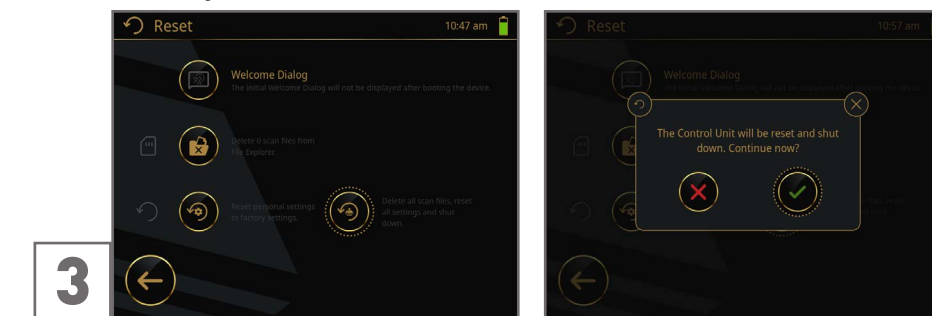

3 Tap on the button to delete all scan files and reset all settings.

You must confirm the action again before it is executed.

4.5.6 Information

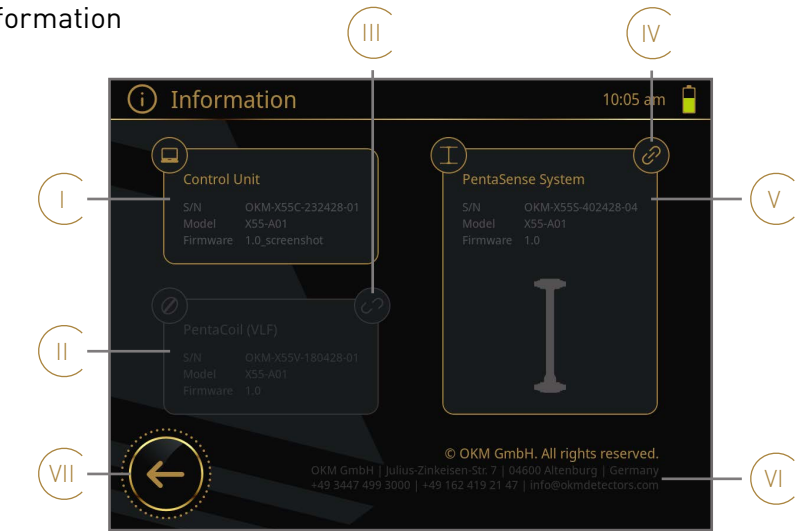

- I Control Unit information shows the serial number, model number and current Firmware version of the Control Unit.
- II PentaCoil information shows the serial number, model number and current Firmware version of the current/last connected PentaCoil.
- III Connection state indicating that the probe/coil is not connected.
- IV Connection state indicating that the probe/coil is connected.
- V PentaSense System information shows the serial number, model number, current Firmware version and Enhancer configuration of the current/last connected PentaSense System.
- VI Contact details comprising OKM's address, phone number, WhatsApp number and email address for further support.
- VII Back arrow: Tap to exit Information and return to the Settings menu.

4.6 PAIR/CONNECT BLUETOOTH HEADPHONES

The acoustic feedback can be provided by headphones instead of the Control Unit speakers in order to avoid attracting attention.

We recommend to use the included OKM Open-Ear Headphones. Alternatively, you can connect your own Bluetooth headphones.

Once the Bluetooth headphones have been successfully paired, they will usually connect automatically the next time they are switched on.



1

Open *Settings*.

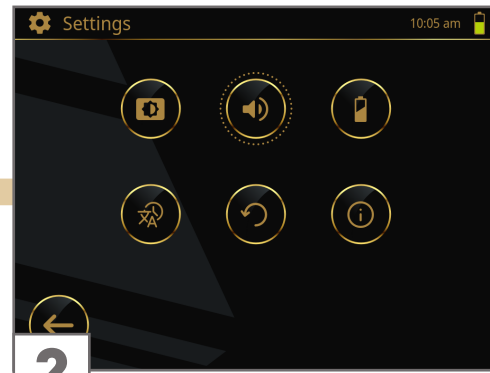

2

Select the option *Sound*.



3

Switch on the OKM Open-Ear Headphones and press the buttons + and - simultaneously for 5s to activate the pairing mode (LED will flash red and blue alternately).

For further information, please refer to the Headphones Manual.

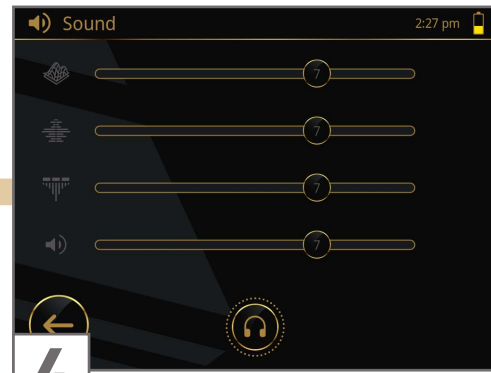

4

Tap on to scan for available Bluetooth devices.

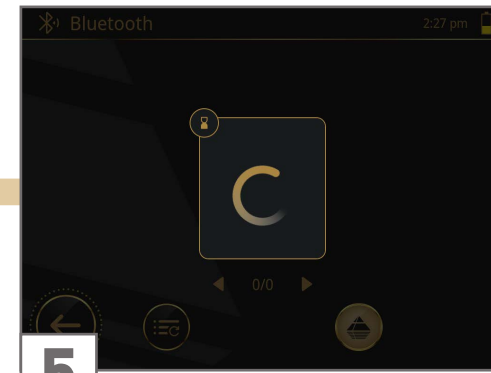

5

The LED ring around the Knob flashes blue while scanning for Bluetooth devices. Wait until the process is complete (approx. 15s).



6

A list with available Bluetooth devices is displayed. Tap on *OKM Headphones*.

Tap on the button to filter Bluetooth devices in the list: Toggle between **all** or **OKM only**.

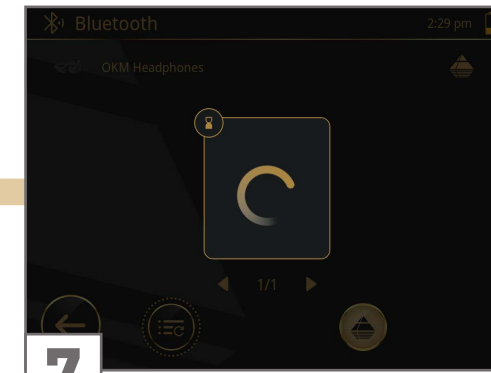

7

Wait until the pairing and connecting process is complete. The LED ring around the Knob flashes blue while pairing and connecting.

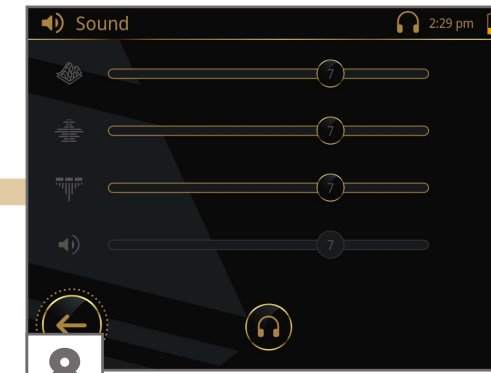

8

As soon as the headphones are successfully connected, you will see the Sound Settings. The symbol in the top bar indicates that the headphones are successfully connected.

The volume of the headphones is set directly at the headphones using the buttons + and -.

For further information, please refer to the Headphones Manual.

OPERATIONS

5 OPERATIONS

The integrated Bluetooth components comply with part 15 of the FCC Regulations. Operation is subject to the following two conditions: (1) this device may not cause harmful interference, and (2) this device must accept any interference received, including interference that may cause undesired operation.

Magnetic fields and metallic objects influence the scan results. Keep the probes away from electric motors, speakers, phones, and keys:

- PentaSense System at least 50m | 160ft,
- PentaCoil at least 2m | 7ft from metallic objects,
- PentaCoil at least 15m | 49ft from active sources of interference, e.g. other detectors.

Remove visible metallic objects such as cans, nails, screws or debris from your scan field before performing measurements with the detector.

5.1 PACEMAKERS

The PentaSense System is a passive measuring instrument that does not emit magnetic waves. The PentaCoil is an active measuring instrument that does emit electro-magnetic fields. When used in accordance with the instructions, metal detectors are generally not known to interfere with pacemakers. Clarify possible interferences with your medical doctor if you are wearing a pacemaker or similar medical device.

5.2 CAUTION DURING EXCAVATION

	DANGER
	<p>Do not touch detected ammunition! Report it to the police!</p>









Once you get a clear target signal, excavate the area around the target object carefully to prevent damage to a potential rare find and minimize the possibility of accidentally detonating old ammunition.

Note the color of the soil close to the surface: A reddish color can be an indicator of rust trace of various kinds of fuses.

Pay attention to the shape of target objects: Curved or round objects can be coins or wedding bands, but may also be parts of ammunition. If you identify buttons, rings or little pegs, excavate particularly carefully.

5.3 OPERATING MODES

The following operating modes are available in the OKM eXp 5500 Professional application:

	Magnetometer*	see 5.4 Magnetometer on page 26
	3D Ground Scan*	see 5.5 3D Ground Scan on page 28
	VLF Metal Detection*	see 5.7 VLF Metal Detection on page 40
	File Explorer	see 5.6 File Explorer on page 36
	Settings	see 4.5 Settings on page 19
	Shutdown	Tap to power off the Control Unit. Confirm the dialog with  OR cancel shutdown and return to the Main Menu with  .

*These operating modes are available as soon as the correct probe is connected.

5.4 MAGNETOMETER

Use the operating mode Magnetometer to detect small metal objects like nails, screws and wires made of ferromagnetic materials such as iron, nickel and cobalt close to the surface. Remove these items from the scan field before performing further scans!

The fewer small metal items in the soil, the deeper you can detect targets with 3D Ground Scan. Moreover, use Magnetometer to pinpoint objects during excavation.

5.4.1 Prepare Measurement

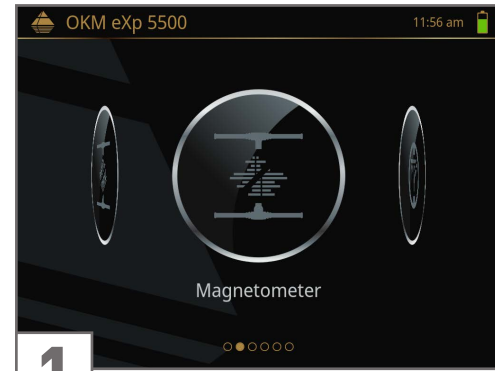

1

Connect the Super Sensor/PentaSense System – see 3.2 PentaSense System on page 13.



2

Open Magnetometer. The operating mode will start immediately.

5.4.2 Measurement Screen

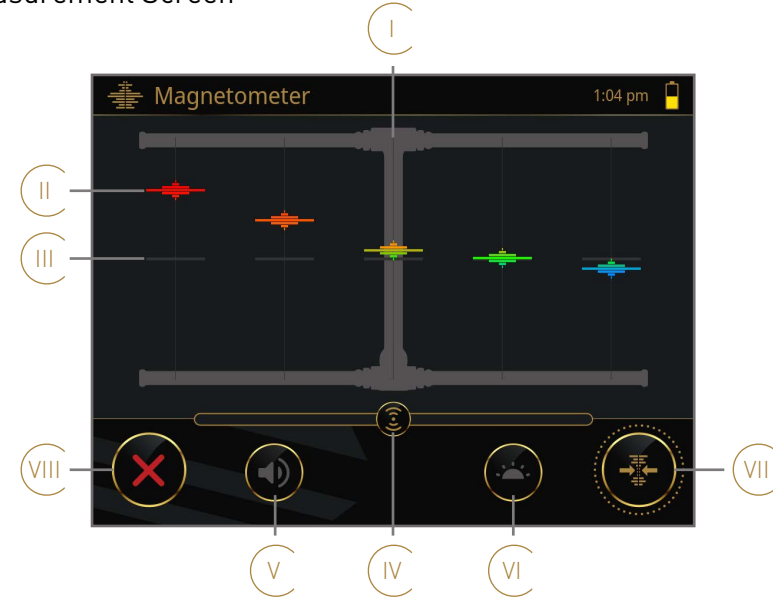

- I PentaSense System shows the Super Sensor with currently connected Enhancers.
- II Magnetometer signals represent values immediately as color-coded graphs for each individual pair of sensors.
- III Zero line represents neutral ground.
- IV Sensitivity: Slide to decrease/increase the detection sensitivity. Set lower sensitivity when using Magnetometer on rough terrain or on scan fields with high mineralization.
- V Sound: Tap to (de)activate the acoustic feedback.
- VI LED Orbit: Tap to (de)activate the visual feedback.
- VII Ground Balance: Place the probe above neutral ground (no objects underground) and tap on the icon to reset the sensors.
- VIII Cancel: Exit Magnetometer and return to the Main Menu.

5.4.3 Perform Measurement

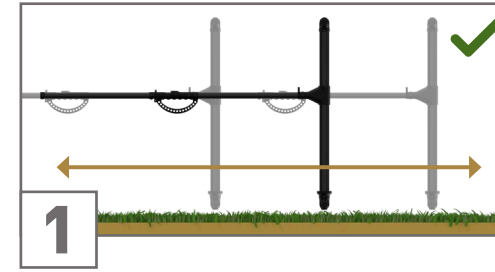

1

Hold the probe vertically. Move the detector back and forth.

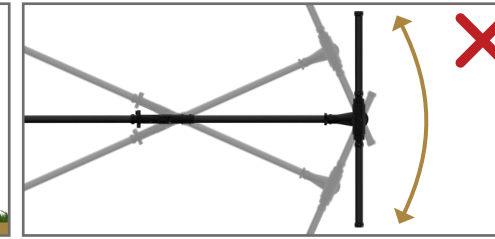

Keep the orientation of the probe parallel to your starting orientation.

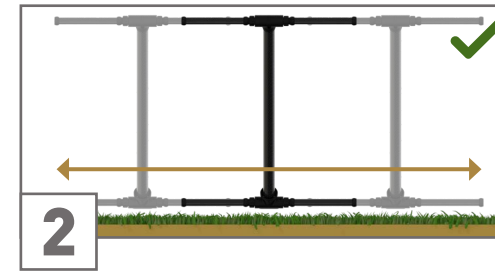

2

Move the detector to the left and right.



Do not pivot, swing or rotate the probe.

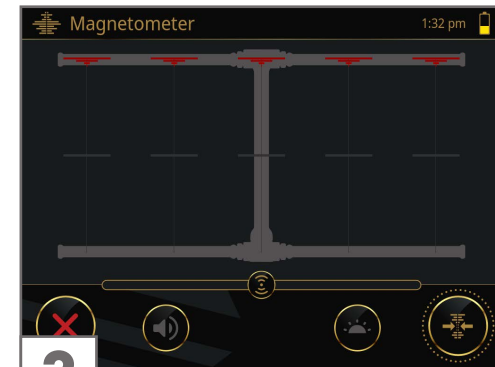

3

If the graphs become unstable or are "frozen", place the probe above neutral ground (no objects underground).

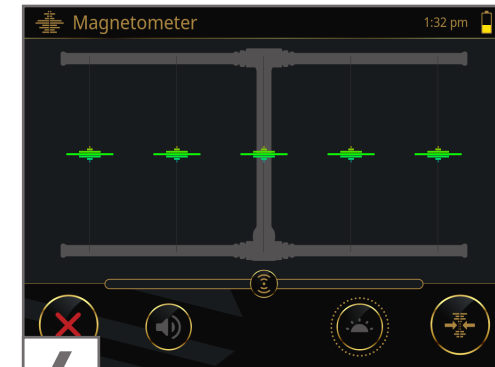

4

Tap on to perform a Ground Balance. The graphs will be reset to the zero line.

5.4.4 Interpret Measurement

As soon as the sensors detect a potential target, you get immediate feedback:

- acoustic feedback (if Sound is enabled),
- direct visual feedback (if LED Orbit is enabled) and
- detailed visual representation for each individual pair of sensors.

The LED orbit shows the color of the signal with the maximum amplitude.

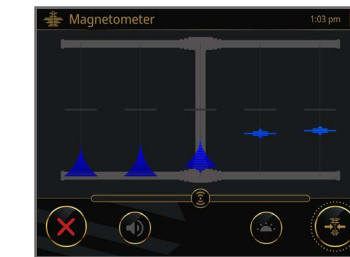

The graph shows **BLUE** peaks if the probe is pointing at the negative magnetic pole of a ferrous object.

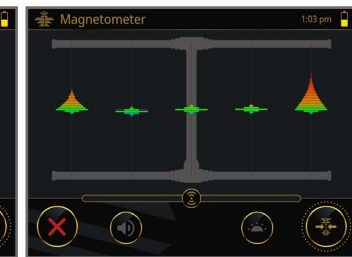

The graph is in the **GREEN** range (close to zero line) if there is no ferrous or magnetic target object.

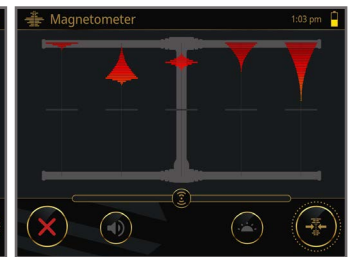

The graph shows **RED** peaks if the probe is pointing at the positive magnetic pole of a ferrous object.

The values are visualized as color-coded graphs for each individual pair of sensors:

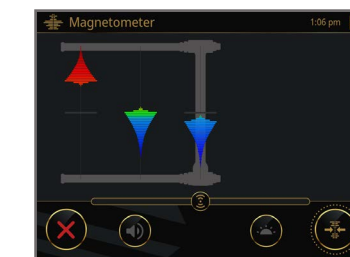

2 Enhancers plugged into the left side of the Super Sensor.

The graphs indicate a ferrous object with strong positive pole (**RED**, left) and medium negative pole (**BLUE**, center and right).



Super Sensor without Enhancers.

The graph indicates a weak to medium signal.

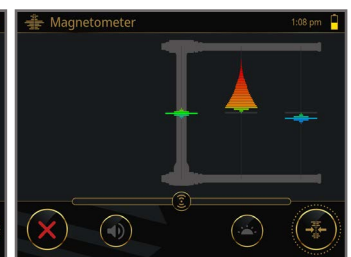

2 Enhancers plugged into the right side of the Super Sensor.

Graphs indicate a small ferrous object with medium positive pole (**REDDISH**, center) and weak negative pole (**BLUE**, right).

5.5 3D GROUND SCAN

Use the operating mode 3D Ground Scan to get a detailed visualization of underground structures and potential target objects for further analysis in Visualizer 3D Studio.

Learn more in the 3D Ground Scan Guide at www.okmdetectors.com/3d-ground-scan-guide

5.5.1 Configure Measurement



1

Connect the Super Sensor/PentaSense System – see 3.2 PentaSense System on page 13.



2

Open the operating mode 3D Ground Scan.

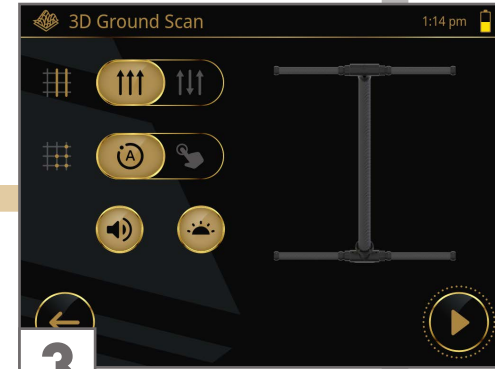

3

The recommended parameters for fast and easy scans are:

Scan Mode: Parallel
Impulse Mode: Automatic
Sound: ON
LED Orbit: ON

Impulse Mode Automatic (A)
The impulses (scan values) are recorded continuously without any break.

Scan Mode Parallel ↑↑↑
Scan all lines in the same direction.

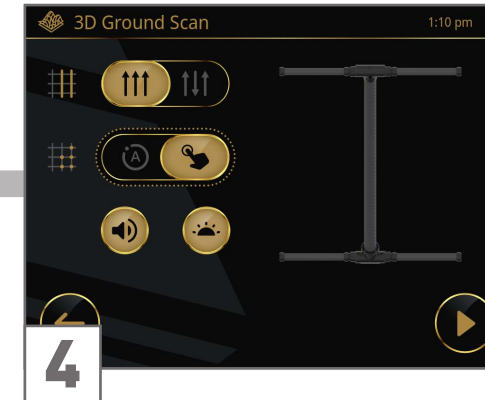

4

For rough terrain, you can select the Impulse Mode Manual: Every single impulse (scan value) requires the Knob/▶ to be pressed.



5

Regardless of the selected scan mode and impulse mode, you can tap on 🔊 to switch OFF the Sound ...

Very experienced OKM users can select the Scan Mode Zigzag ↑↓↑ to scan all scan lines forwards and backwards alternately.

... and/or 🌑 to switch OFF the LED Orbit.

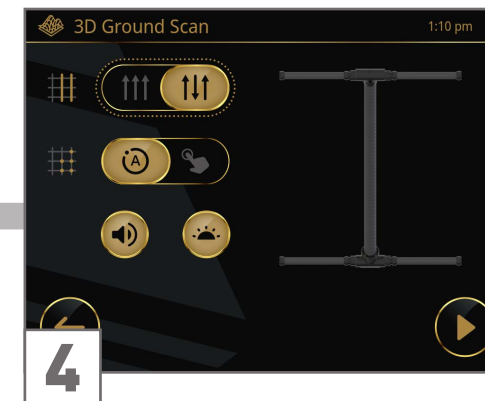

4

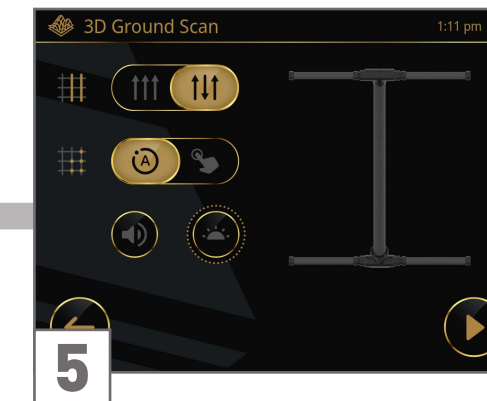

5



6

Ready to start your 3D Ground Scan.
Continue with 5.5.3 Perform Manual 3D Ground Scan on page 32.

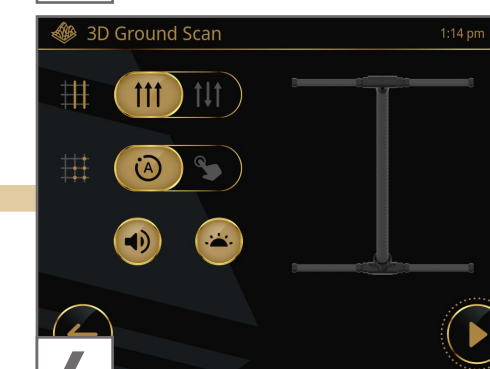

6

Ready to start your 3D Ground Scan.
Continue with 5.5.2 Perform Default 3D Ground Scan on page 30.

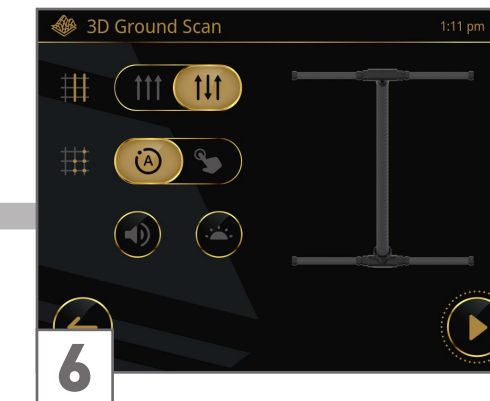

6

Ready to start your 3D Ground Scan.
Continue with 5.5.4 Perform Zig-zag 3D Ground Scan on page 34.

5.5.2 Perform Default 3D Ground Scan

The default parameters (Scan Mode: Parallel | Impulse Mode: Automatic) are recommended for entry-level detector users and allow scanning in flat and wide as well as slightly sloping terrain.

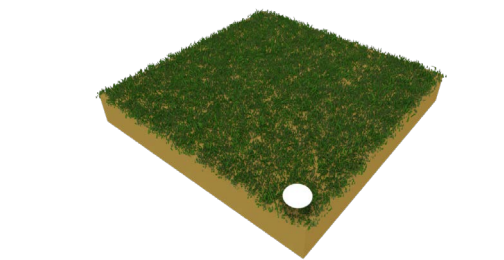
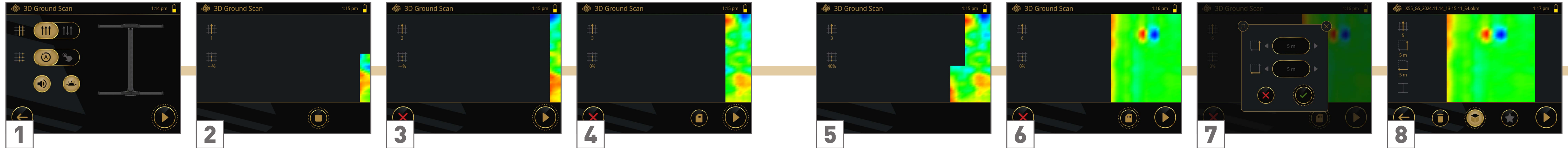

Go to the starting point of the first scan line (bottom right corner).
Press ► or push the Knob to start scanning. Start walking as soon as you press ►.

The first scan lines may initially look incorrect. However, the inconsistent scan image will stabilize in the course of the scan.



Walk to the end of the first scan line. Press ■ or push the Knob as soon as you reach its end to set the field length for all following lines.
The scan image will be generated line by line to help you to follow your progress while measuring.

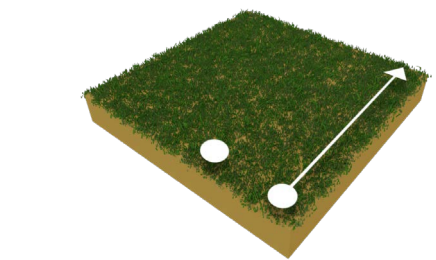

Return to your first starting point without scanning and take one step to the left: This is the starting point of the second scan line.

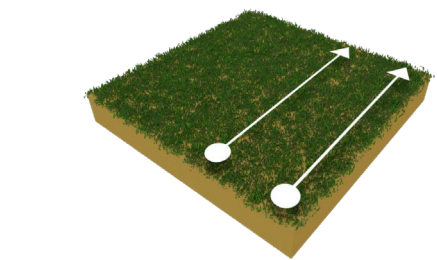

Press ► or push the Knob to start scanning. Start walking as soon as you press ►.
Walk parallel to your first scan line and at the same speed. The impulse sound should stop at the end of the line.

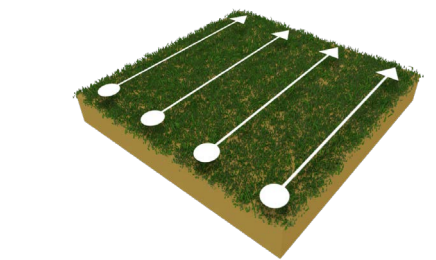

Return to the previous starting point and take a step to the left (without scanning): This is the starting point of the next scan line.
Press ► or push the Knob to start scanning and walk at the same speed until you reach the end of the scan line.
Repeat this to scan as many lines as you like.

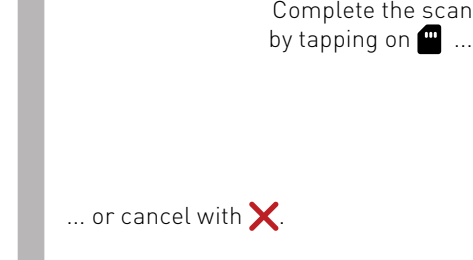

Complete the scan by tapping on ■ ...
... or cancel with ✖.

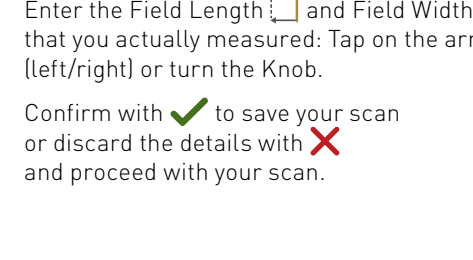

Enter the Field Length [] and Field Width [] that you actually measured: Tap on the arrows (left/right) or turn the Knob.
Confirm with ✔ to save your scan or discard the details with ✖ and proceed with your scan.

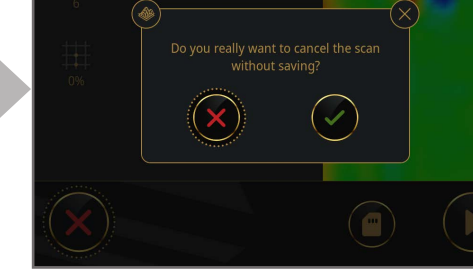

Confirm with ✔ to discard the scan and return to the Main Menu OR return to your scan procedure with ✖.

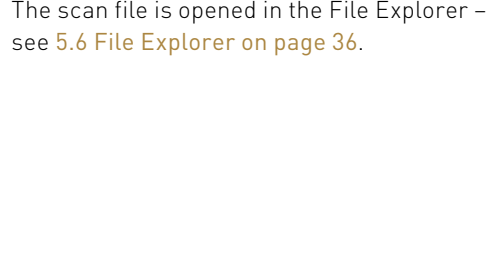

The scan file is opened in the File Explorer – see 5.6 File Explorer on page 36.

5.5.3 Perform Manual 3D Ground Scan

The parameters (Scan Mode: Parallel | Impulse Mode: Manual) are recommended for very rough terrain.

In Impulse Mode *Manual* each single impulse (scan value) is triggered manually one after the other at its own pace by pressing or pushing the Knob.

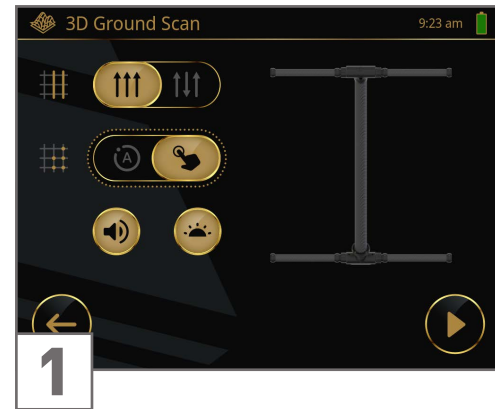

Go to the starting point of the first scan line (bottom right corner).
Press or push the Knob to start the first scan line.

The first scan lines may initially look incorrect. However, the inconsistent scan image will stabilize in the course of the scan.

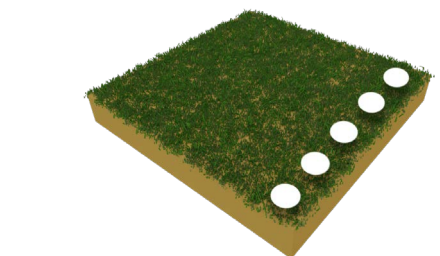
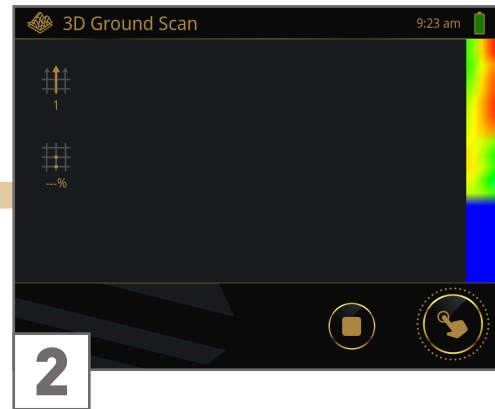

Take a step forward and press or push the Knob to record an impulse. Continue in this way until you reach the end of the first scan line.
Tap on to finish the first line and thereby set the field length.

The scan image will be generated line by line to help you to follow your progress while measuring.

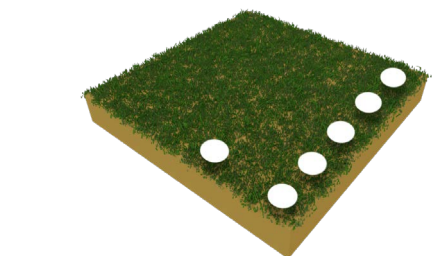
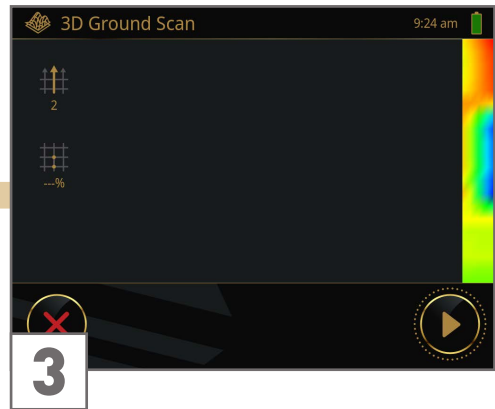

Return to your first starting point without scanning and take one step to the left: This is the starting point of the second scan line.
Press or push the Knob to start the second scan line and record the first impulse of your second scan line.

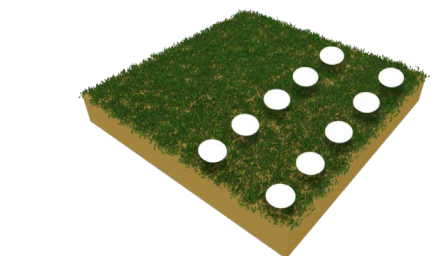
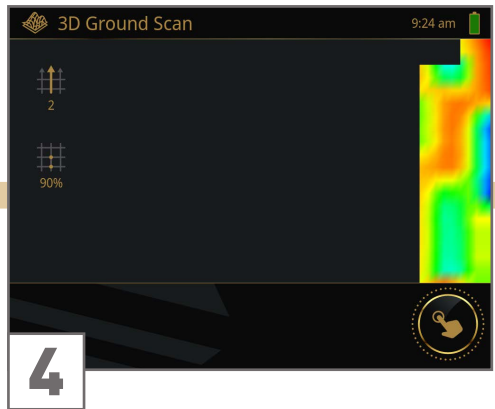

Take a step forward and press or push the Knob to record the next impulse. Continue until you reach the end of the scan line.
Scan parallel to your first scan line with the probe heading into the same direction as in the first scan line.

The progress is indicated on the left. At 100% you have reached the end of the scan line. This is also indicated by an acoustic signal (if Sound is enabled).

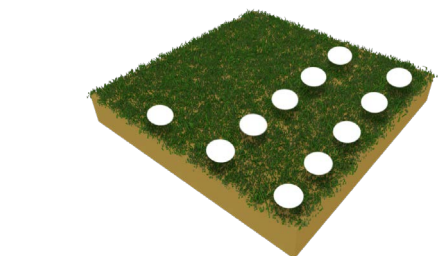
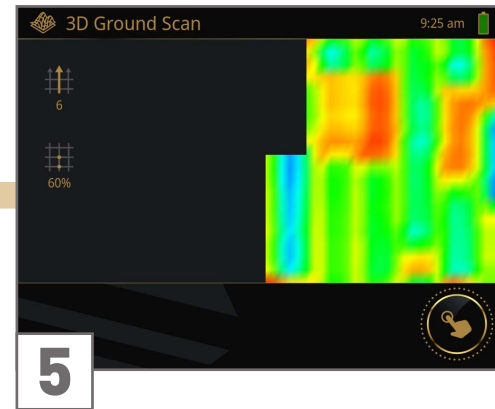

Return to the previous starting point and take a step to the left (without scanning): This is the starting point of the next scan line.
Press or push the Knob to start the scan line. Press or push the Knob to release an impulse at each step forward until you reach the end of the scan line.

Repeat this to scan as many lines as you like.

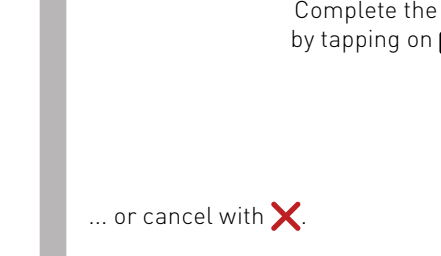
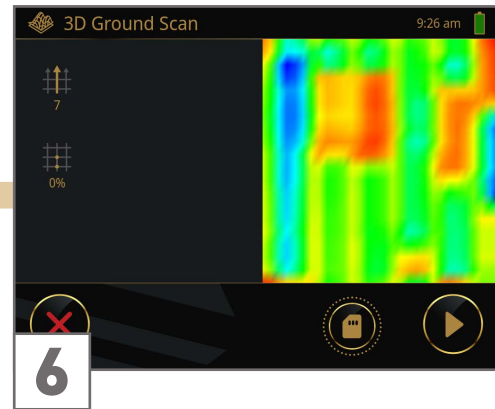

Complete the scan by tapping on ...
... or cancel with .

Confirm with to discard the scan and return to the Main Menu OR return to your scan procedure with .

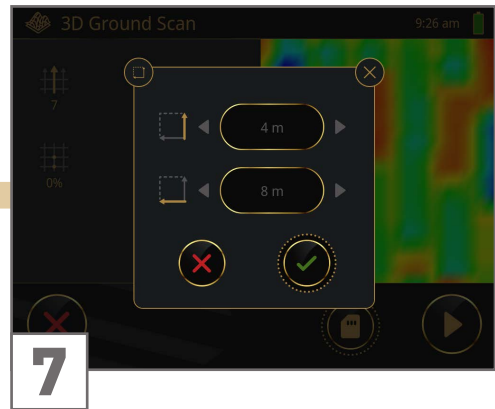

Enter the Field Length and Field Width that you actually measured: Tap on the arrows (left/right) or turn the Knob.
Confirm with to save your scan or discard the details with and proceed with your scan.

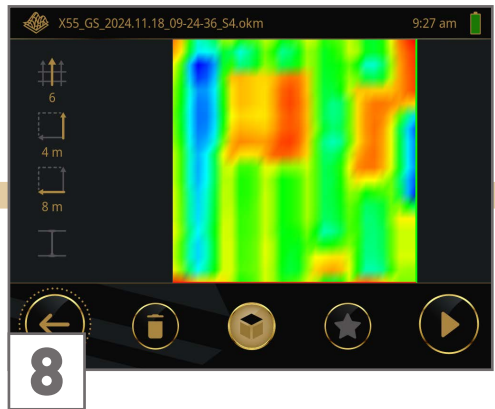

The scan file is opened in the File Explorer – see 5.6 File Explorer on page 36.

5.5.4 Perform Zigzag 3D Ground Scan

The parameters (Scan Mode: Zigzag | Impulse Mode: Automatic) are recommended for advanced detector users and can be applied in flat terrain.

In Scan Mode *Zigzag* all scan lines are scanned by walking forwards and backwards. However, the scan lines must be parallel to each other and the probe must always point in the same direction as in the first scan line. **Do not turn/rotate the probe during the scan!**

1 Go to the starting point of the first scan line (bottom right corner).
Press ▶ or push the Knob to start scanning. Start walking as soon as you press ▶.

2 Walk to the end of the first scan line. Press ■ or push the Knob as soon as you reach its end to set the field length for all following lines.
The scan image will be generated line by line to help you to follow your progress while measuring.

3 Remain at the end of the scan line and take a step to the left (without scanning).
The probe must always point in the same direction as in the first scan line: Use the arrow on top of the Super Sensor for alignment.

4 Press ▶ or push the Knob to start scanning. Start walking as soon as you press ▶.
Walk parallel to your first scan line but in reverse until you reach the end of the scan line.
Walk at the same speed as in the first scan line. The impulse signals should stop as soon as you reach the end of the line (if Sound is enabled).

5 Remain at the end of the scan line and take a step to the left (without scanning).
Press ▶ or push the Knob to start scanning. Walk parallel to the first scan line (forwards) and at the same speed until you reach the end of the scan line.
Repeat steps 3 to 5 to scan as many lines as you like: Odd scan lines forwards, even scan lines backwards.
The current scan line direction (forwards/backwards) is indicated by the golden arrows ⚡ and ⚡ on the left.

6 Complete the scan by tapping on 🗨️ ...
... or cancel with ✖.

7 Enter the Field Length [] and Field Width [] that you actually measured: Tap on the arrows (left/right) or turn the Knob.
Confirm with ✔ to save your scan or discard the details with ✖ and proceed with your scan.

8 The scan file is opened in the File Explorer – see 5.6 File Explorer on page 36.

The first scan lines may initially look incorrect. However, the inconsistent scan image will stabilize in the course of the scan.

5.6 FILE EXPLORER

Use File Explorer to view your stored scan files directly on the eXp 5500 display and to transfer files between the Control Unit and your Windows notebook.

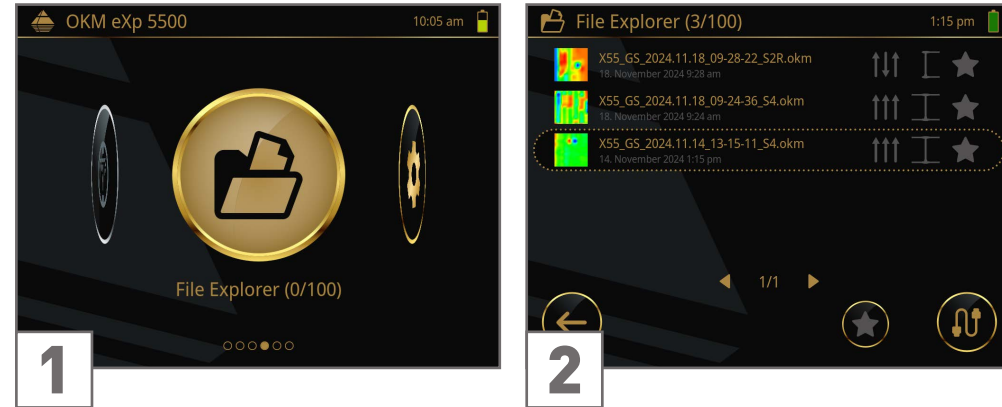

Open File Explorer. The digits in brackets show the number of scan files that are currently stored. The maximum number of scan files that can be stored is 100.

Tap directly on a scan file or select a row and push the Knob to open a scan file.

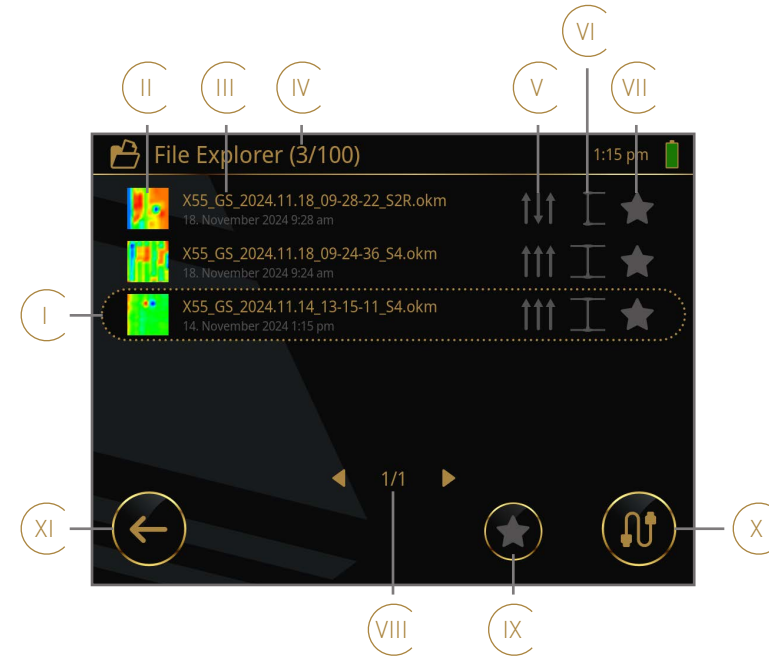

- | | |
|------|---|
| I | The selection frame helps to navigate through the list and select scan files. |
| II | Scan file thumbnail shows a small preview of the measurement. |
| III | Scan file details: The file name includes coded information about operating mode, date, time and sensor modules. The second row shows the scan date and time in the formats as defined in 4.5.4 Regional Preferences on page 20 . |
| IV | Number of currently stored scan files. The maximum number of scan files is 100. |
| V | Scan Mode that was defined for the corresponding measurement. |
| VI | Enhancer setup shows the chosen configuration of the PentaSense System. |
| VII | Starred: Indicates which scan files are currently marked as favorites. |
| VIII | Page indicator shows your current position in the File Explorer. |
| IX | List filter <i>Favorites</i> : Tap to show only scan files that have been marked as favorites. |
| X | Transfer Mode: Tap to start the Transfer Mode – see 5.6.2 Transfer Files on page 38 . |
| XI | Back arrow: Tap to exit File Explorer and return to the Main Menu. |

5.6.1 Review 3D Ground Scan

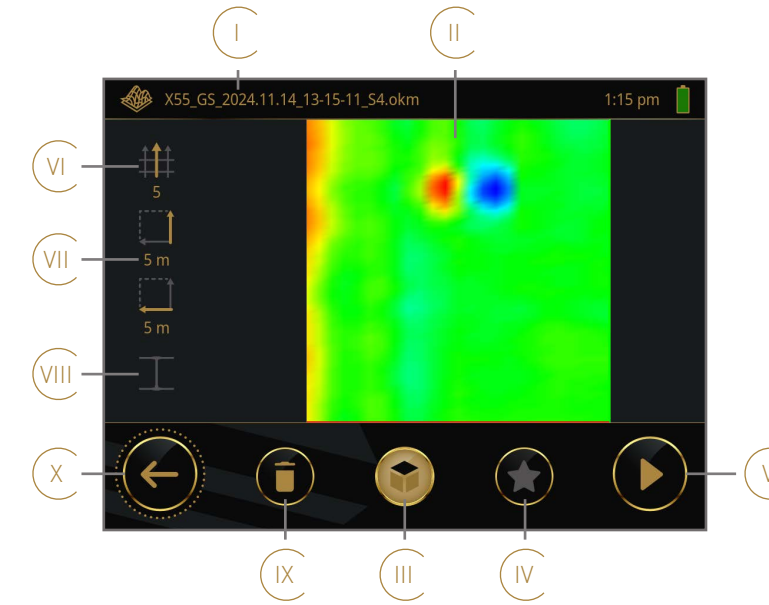

- | | |
|------|---|
| I | Scan file name includes coded information about operating mode, date, time and sensor modules. |
| II | Scan file image is displayed in top view first. |
| III | Views: Tap on the button to toggle between top view and perspective view . |
| IV | Favorite: Tap to mark/unmark the scan file as favorite. |
| V | Replay the scan progress over the course of the measurement. |
| VI | Scan information indicates the scan mode and number of scan lines. |
| VII | Scan field dimensions show the entered field length and field width. Tap on the icons to edit the entered dimensions. |
| VIII | Enhancer setup shows the chosen configuration of the PentaSense System. |
| IX | Delete the single scan file. |
| X | Back arrow: Exit the Scan Preview and return to the File Explorer. |

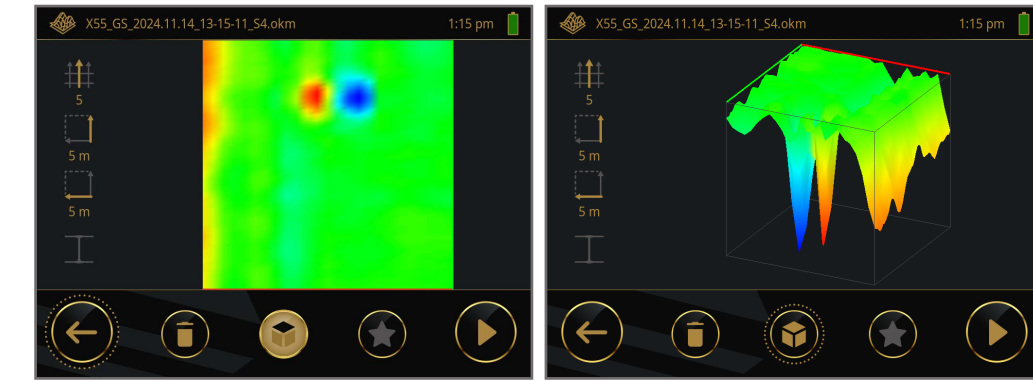

3D Ground Scan in Top View [2D]

3D Ground Scan in Perspective View [3D]

Use intuitive gestures to rotate, move, or scale the 3D Ground Scan image on the display:

- Rotate: Drag by moving one fingertip over the screen to rotate the scan image.
- Move: Touch with two fingers and drag the scan image to the desired spot.
- Scale: Pinch to zoom out and spread to zoom in.

Replay the scan process to recognize smaller signals that may have been displaced by larger signals in the course of the measurement.

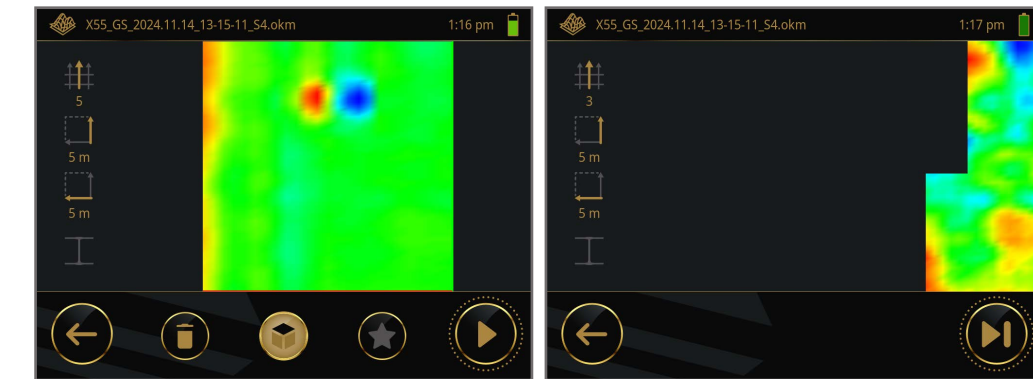

Tap on to start the Scan Replay.

Tap on to stop the replay.

Turn the Knob counterclockwise to speed up the process or clockwise to slow it down. Tap on to return to the File Explorer.

For a more detailed analysis, transfer the scan files to a Windows notebook and open them in Visualizer 3D Studio – see [5.6.2 Transfer Files on page 38](#).

5.6.2 Transfer Files

The saved 3D Ground Scan files are stored in the internal memory of the Control Unit. The maximum number of scan files that can be stored is 100.



1 Open *File Explorer* on your Control Unit.

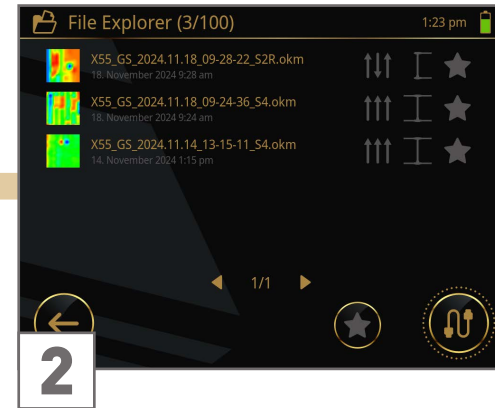

2 Tap on to start the **Transfer Mode**.

An animated LED sequence around the Knob indicates that the Transfer Mode is active.

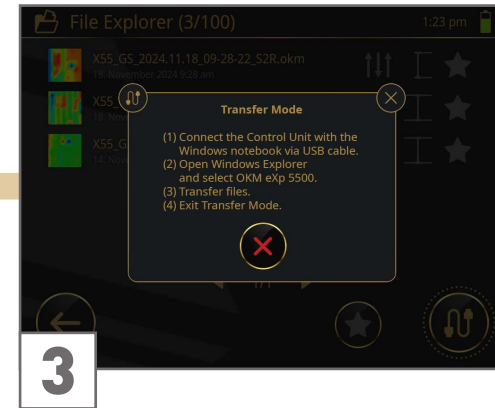

3 Follow the instructions on the screen.



4 (1) Connect the Control Unit with the Windows notebook via USB-C cable.

If your notebook does not have a USB-C socket, you can use a standard USB-C to USB-A adapter.

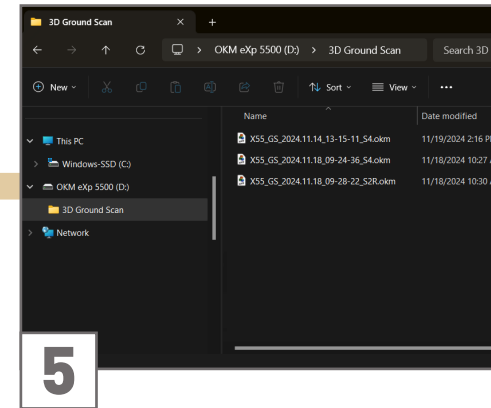

5 (2) Open *Windows Explorer* and select **OKM eXp 5500**.

Find your 3D Ground Scan files in the corresponding folder in the *Windows Explorer* on your notebook.

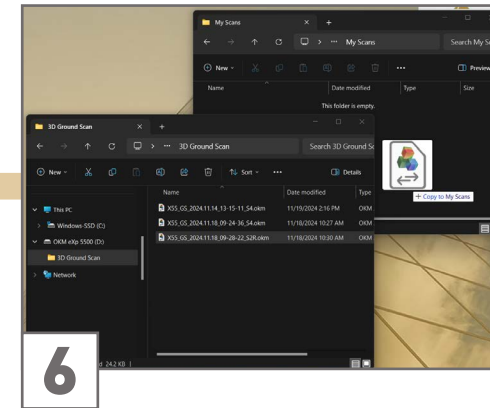

6 (3) Transfer Scan Files.

You can now copy or move scan files to your notebook and open them in *Visualizer 3D Studio*.

Moreover, you can transfer update files from the notebook to the Control Unit to run firmware updates – see [6.3 Firmware Updates on page 46](#).

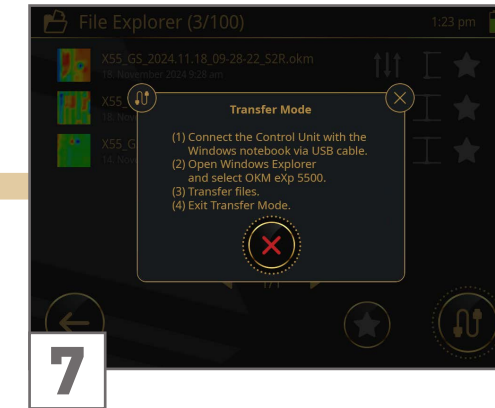

7 (4) Exit Transfer Mode.

Tap on to exit the Transfer Mode and return to the *File Explorer*.

5.7 VLF METAL DETECTION

Use the VLF Metal Detection mode to detect metal objects at shallow depths in the ground.



1 Connect the PentaCoil (VLF Coil) – see 3.5 PentaCoil + Telescopic Rod on page 15.

2 Open the operating mode VLF Metal Detection.

5.7.1 Configure Measurement

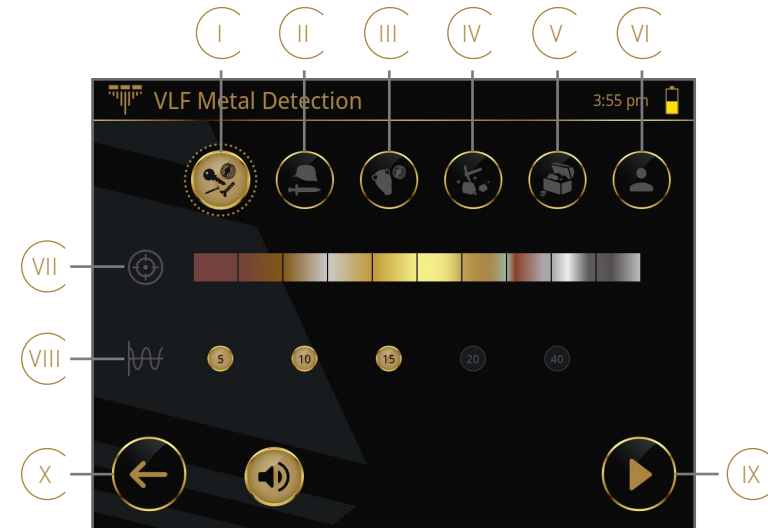

	Scan Profile	Type of Metal	Target-ID Zones	Frequencies
I	All Metal keys, coins, nails, screws, jewelry, artifacts, weapons	iron, steel, aluminum, gold, brass, bronze, copper, silver, lead	0-99	5 10 15 kHz
II	Militaria armor, badges, weapons, ammunition, accessories, aircrafts, vehicles	iron, steel, aluminum, brass, bronze, lead	0-39 80-99	5 10 15 kHz
III	Relics coins, jewelry, vessels, artifacts, ceramics, tools, figurines	silver, gold, bronze, copper	50-99	10 15 20 kHz
IV	Gold jewelry, coins, bars	gold	20-89	10 20 40 kHz
V	Treasures treasure chests, coin hoards, vessels	iron, gold, bronze, copper, silver	0-9 50-99	5 10 40 kHz
VI	Custom	Set your preferences according to your experience.		
VII	Target-ID is used to distinguish between the different types of metal objects. Show/hide Target-ID zones according to your preferences. Target-IDs range from 0 to 99:			
	The colored scale corresponds to the 100 Target-IDs, grouped into 10 zones. Due to the fact that the Target-ID depends on the shape, properties, material composition and position of the target object, the resulting Target-ID can vary even for the same object. Thus, the zone colors provide only a vague indication of possible metal types. Over time, you can use your experience to gain your own discrimination expertise in order to make your metal detection more efficient.			
VIII	Frequency: Choose between single and multi-frequency operation by selecting up to 3 frequencies. Low frequencies tend to give more depth to large targets. High frequencies tend to be more sensitive to small targets. If you are experiencing excessive ground noise at a particular location, you may switch to a single frequency to eliminate it.			
IX	Continue: Tap to proceed with the Ground Balance – see 5.7.2 Perform Ground Balance on page 41.			
X	Back arrow: Tap to exit VLF Metal Detection and return to the Main Menu.			

5.7.2 Perform Ground Balance

Ground balancing reduces the interference signals ('noise') caused by ground mineralization and allows clearer detection of targets. In VLF Ground Balance, the detector selects the 'quietest' signal channel based on various criteria.

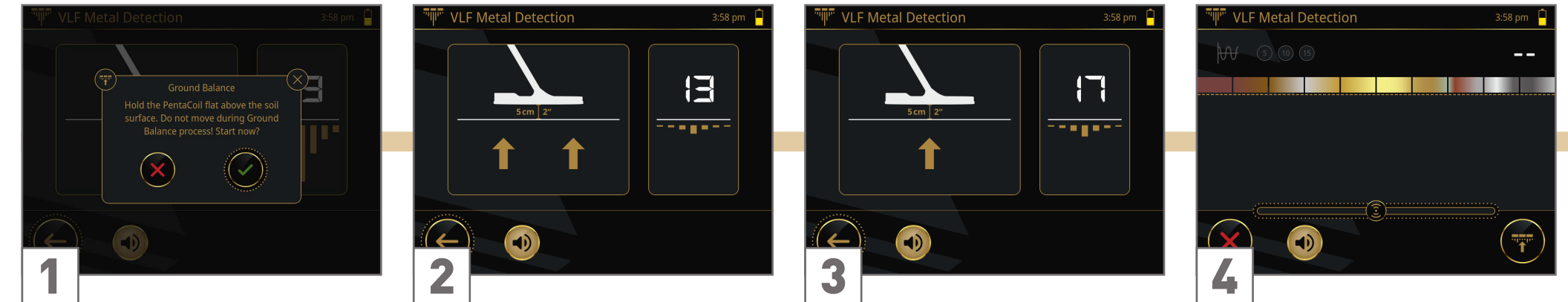

1 Place the coil on neutral ground (no objects underground). Hold it approx. 5 cm | 2" above the soil surface and do not move it. As soon as you are ready, start the Ground Balance with ✓.

2 The progress is indicated on the left by two arrows moving towards each other. This can take up to 10 seconds.

3 When finished, both arrows are in the target position and the 'quietest' ground value is displayed on the right. This value is saved for the current measurement.

4 If the Ground Balance is successful, you will hear a confirmation signal (2x high-pitch beep, if Sound is enabled) and the scan screen is displayed immediately.

A new Ground Balance may be recommended/required during the measurement if the detected signals become unstable due to changes in the soil.

If the Ground Balance failed, you will hear an error signal (2x low-pitch beep, if Sound is enabled) and see an error notification. Place the coil in a new position and repeat the process.

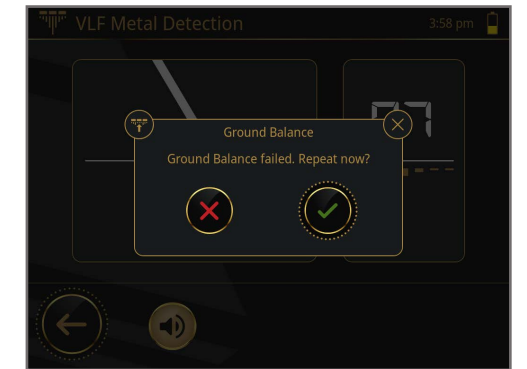

5.7.3 Measurement Screen

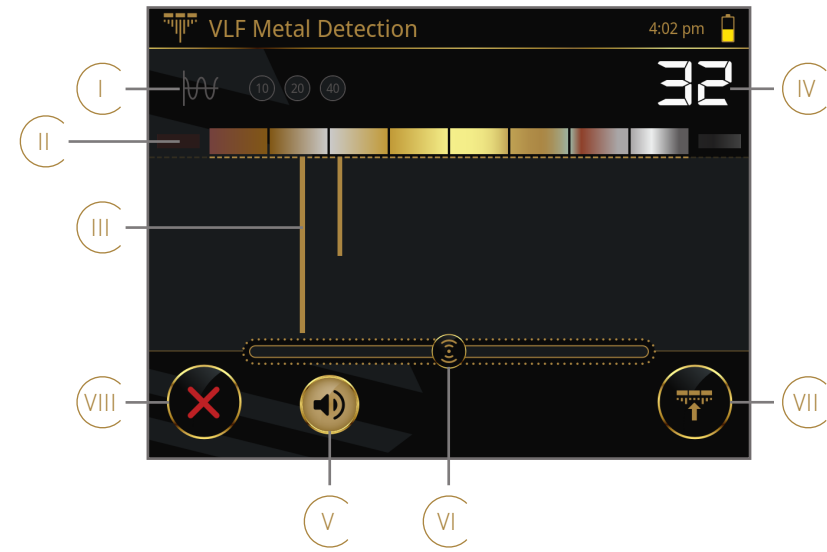

- I Frequencies that have been selected during configuration – see [5.7.1 Configure Measurement on page 40](#).
- II Target-ID Zones that were previously selected. Tap on the color boxes even during the active scan to show/hide Target-ID zones. By hiding Target-ID zones, undesired objects can be masked out.
- III Signal shows the maximum amplitude of the detected target object as a bar graph.
- IV Target-ID shows the position of the maximum amplitude in the Target-ID zones 0 to 99.
- V Sound: Tap to (de)activate the acoustic feedback.
- VI Sensitivity: Slide to decrease/increase the detection sensitivity.
- VII Ground Balance: Place the coil above neutral ground and tap on the icon to perform a Ground Balance – see [5.7.2 Perform Ground Balance on page 41](#).
- VIII Cancel: Tap to exit VLF Metal Detection and return to the Main Menu.

5.7.4 Perform Measurement

The eXp 5500 with PentaCoil is a motion detector, which means that the VLF coil must be moved over the ground to detect a target. If the coil is held motionless above a target, it will not detect it. The scan movement from one side to the other is called “swinging”. If the coil is swung inaccurately, you can easily miss objects or generate false signals.

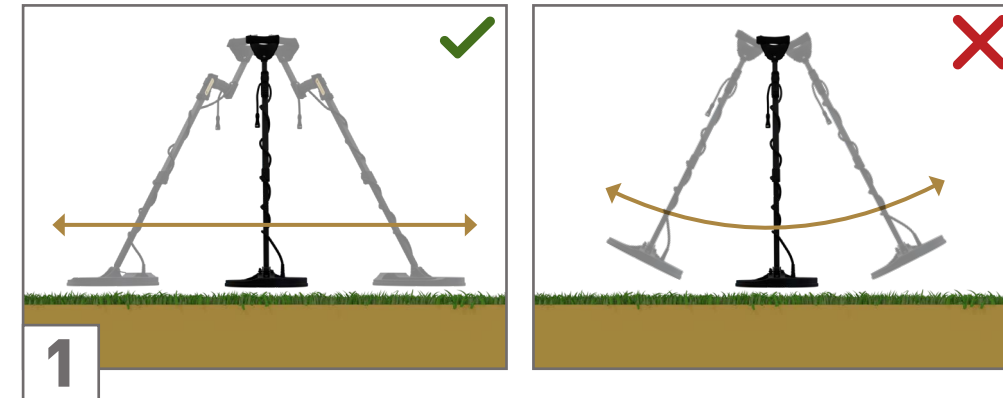

Swing the coil from one side to the other, closely and parallel to the ground (approx. 5 cm | 2" above the soil surface).

Do not sweep the coil along the ground. Avoid too large distances to the ground – especially at the sides.

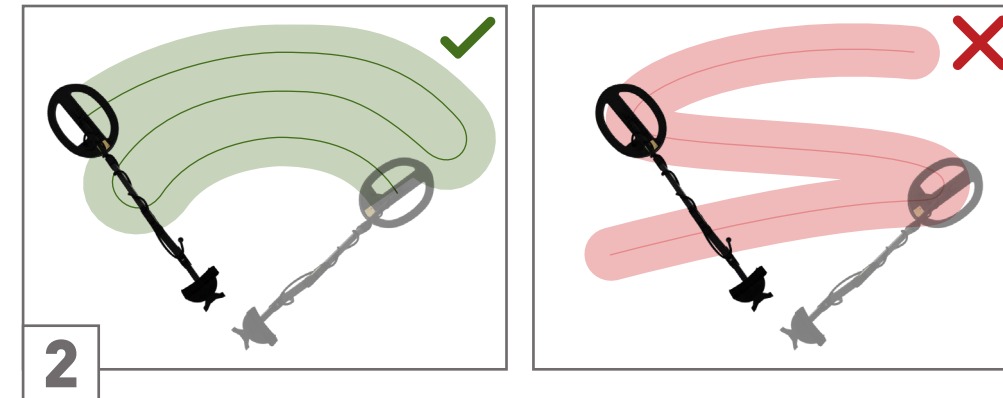

Swing the coil smoothly from one side to the other – approximately at walking pace.

Make sure that the scanned areas overlap with each swing to ensure that the scan field is scanned without skipping potential targets.

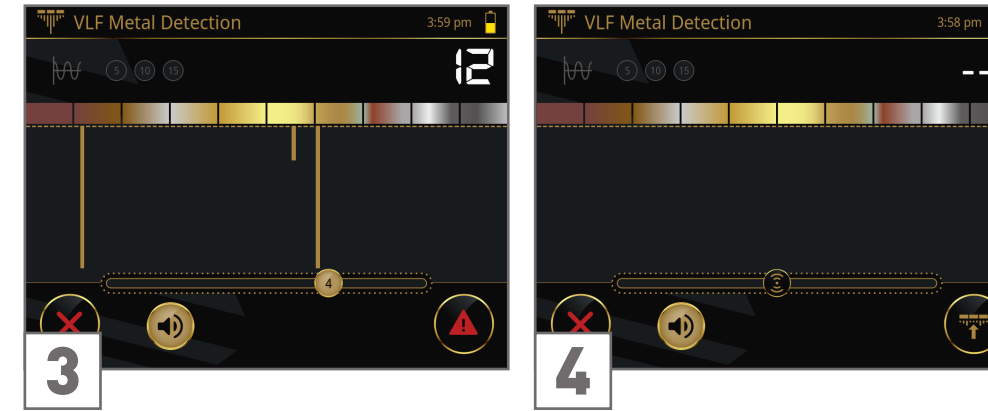

If the signals become unstable, this is indicated by a flashing . If no Ground Balance is performed, you will hear a warning sound every 10s (2x beep, if Sound is enabled).

Place the coil above neutral ground. Tap on to perform a Ground Balance – see [5.7.2 Perform Ground Balance on page 41](#).

During the ground balance procedure, the detector reselects the ‘quietest’ signal channel and returns to the scan screen. The sensitivity will be reset to zero.

5.7.5 Interpret Measurement

As soon as the coil detects a potential target object, you get immediate feedback:

- acoustic feedback (if Sound is enabled),
- visual representation of maximum amplitude as bar graph,
- indication of the position of the maximum amplitude as two-digit Target-ID.

The scan screen shows the signal with the maximum amplitude and its corresponding Target-ID:

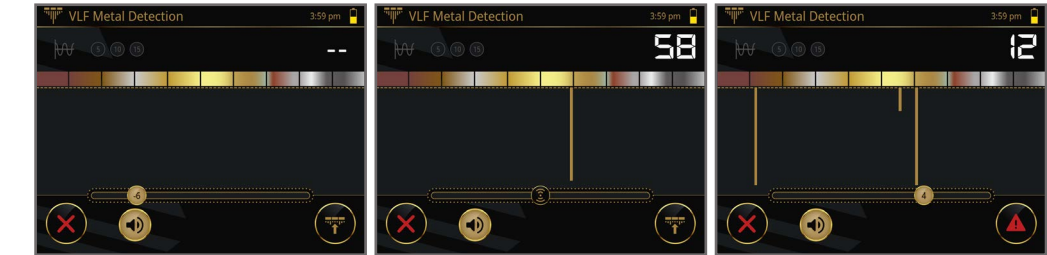

All Target-ID zones are active. No signal detected.

Strong signal detected in one of the active Target-ID zones. Displayed Target-ID is 58.

The signals become unstable. Perform a Ground Balance – see [5.7.2 Perform Ground Balance on page 41](#).

You can show/hide Target-ID zones individually. By hiding Target-ID zones, undesired objects can be masked out. No feedback sound is provided for signals that occur in hidden zones. However, the bar and the Target-ID are still displayed (grayed-out) to ensure that you do not miss any potential target objects.

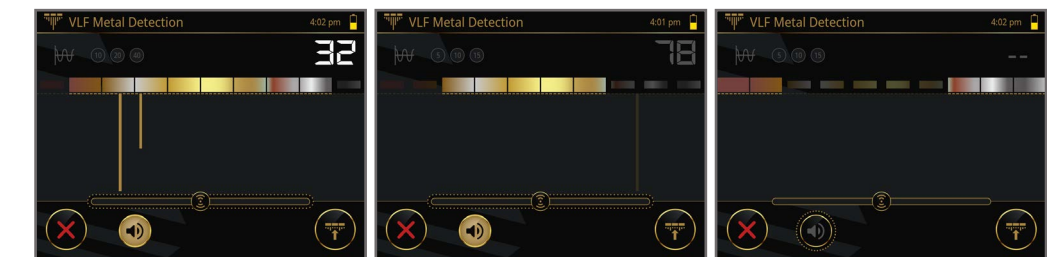

Strong signal detected in focus Target-ID zone: The bar graph and the corresponding Target-ID are highlighted.

Strong signal detected in hidden Target-ID zone: The bar graph and the corresponding Target-ID are grayed out. The acoustic feedback is muted.

Only selected Target-ID zones are active. No signal detected.

MAINTENANCE

6 MAINTENANCE







	<p style="text-align: center;">WARNING</p> <p>ELECTRICAL HAZARD! Keep water away from electronic components and cables.</p>
---	---

6.1 CHECK AND CLEAN CONTROL UNIT AND PROBES

To always get the best performance from your detector, clean it regularly and check it for damages.

- Keep the Control Unit and probes away from strong magnetic fields.
- Avoid penetrating water, dust and dirt. If you cover the Control Unit with a plastic bag, make sure it can 'breathe' to avoid overheating and condensation inside.
- Check for blockages in the probe sockets/probe plugs and charger socket. Remove any dirt and particles.
- Use the Protective Caps to protect the open plugs/sockets from moisture or dirt.
- Clean the Control Unit and probes with a soft, damp, lint-free cloth after each use. Do not use detergents or polishes.
- Recharge the battery regularly, see [4.1.2 Charge Battery on page 17](#).

6.2 REPLACE INTERNAL BATTERY

 <p>1</p>	 <p>2</p>
<p>Turn the Control Unit upside down to view the bottom. Open the battery compartment cover by removing the 6 Torx T10 screws.</p>	<p>Remove the battery carefully.</p>
 <p>3</p>	 <p>4</p>
<p>Disconnect the plug carefully. Make sure to pull the plug instead of the cable.</p>	<p>After replacing the battery, connect the plug of the new battery correctly.</p>
 <p>5</p>	 <p>6</p>
<p>Place the battery carefully back in the compartment. Do not kink or pinch the cable.</p>	<p>Close the battery compartment. Lock its cover with the 6 Torx T10 screws.</p>

6.3 FIRMWARE UPDATES

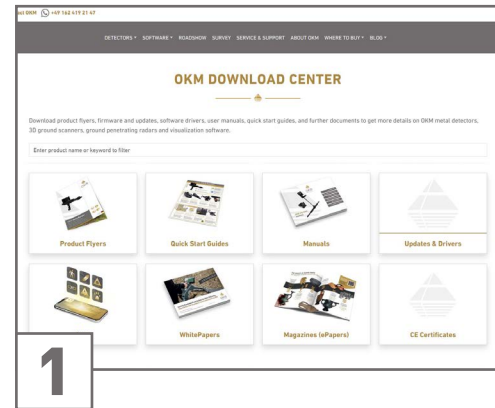

1 Check the OKM Download Center at www.okmdetectors.com/updates for detector updates and download the latest eXp 5500 Pro update file to your Windows notebook.

Update files usually end with the file extension .odu. The latest update is the one with the highest version number within the file name.



2 Open *File Explorer* on your Control Unit.

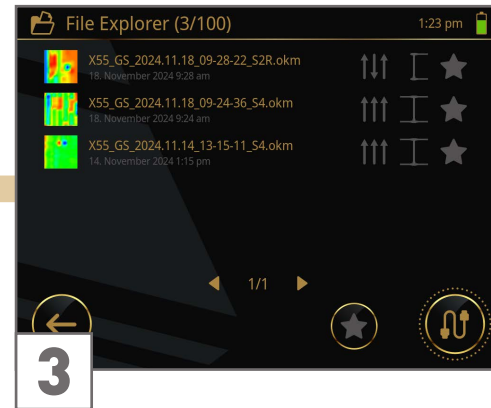

3 Tap on to start the Transfer Mode.
An animated LED ring sequence indicates that the Transfer Mode is active.

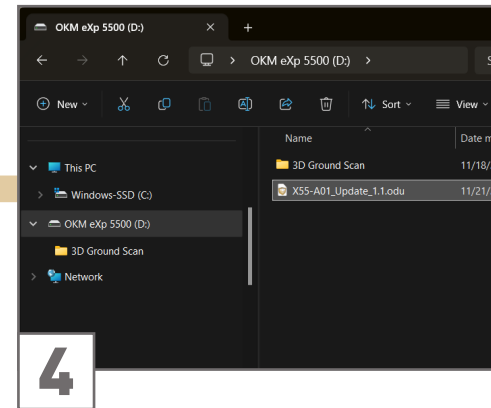

4 Open Windows Explorer on your notebook. Copy the update file from your Windows notebook into the OKM eXp 5500 root directory.

We recommend copying instead of moving the file so that in the event of an error, a backup copy is still available on your Windows notebook, which can be copied again.

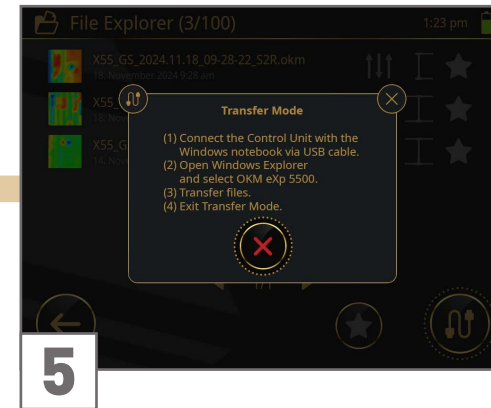

5 Tap on to exit the Transfer Mode and return to the File Explorer.

Each time the Transfer Mode is ended, the Control Unit scans the internal memory for new files. If an update file is detected, you will see the following notification (Step 6).

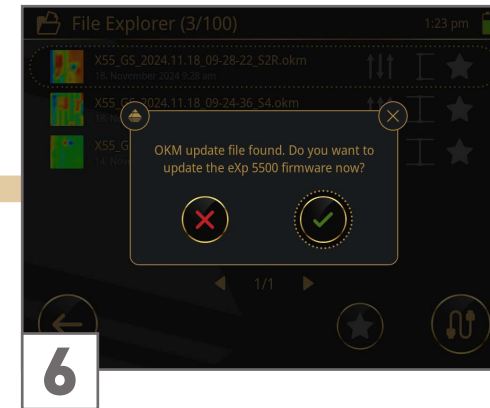

6 Confirm with to execute the update immediately ...

... OR tap on to cancel the update and return to the File Explorer.

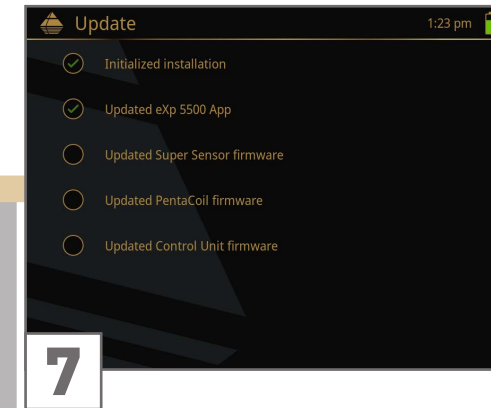

7 Follow the instructions on the screen and wait until the update is complete.

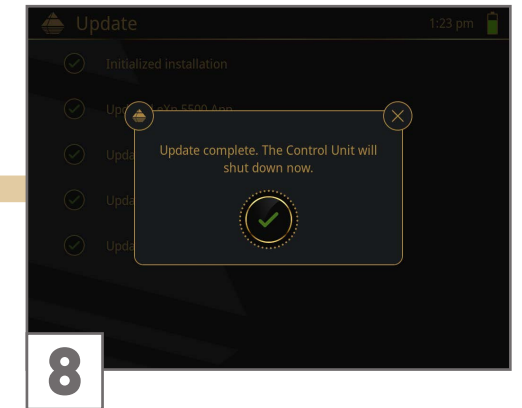

8 Confirm with to shut down the Control Unit. After restarting it, you can use the detector as usual.

Once an update process has been canceled, the OKM eXp 5500 will not ask for it again. Return to Step 2 and repeat the process to trigger an update.

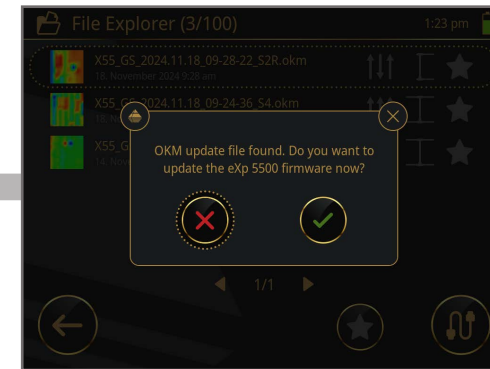

TROUBLESHOOTING

7 TROUBLESHOOTING

ERROR	POSSIBLE PROBLEM	SOLUTION
The Control Unit does not power on.	<p>The internal battery is low or empty.</p> <p>The ambient temperature is too low or too high.</p>	<p>Charge the battery – see 4.1.2 Charge Battery on page 17.</p> <p>Your device won't operate if the ambient temperature is below 14 °F (-10 °C) or higher than 140 °F (60 °C).</p>
The Control Unit does not power off.	The system is overloaded or an unexpected software error has occurred.	<p>Push and hold the Knob for at least 10 seconds to switch off the detector.</p> <p>If pushing and holding the Knob does not power off the Control Unit: Open the battery compartment on the bottom of the Control Unit and remove the battery plug – see 6.2 Replace Internal Battery on page 45. Wait a few seconds and plug the connector back in.</p>
The Control Unit does not start charging.	<p>The ambient temperature is too low or too high.</p> <p>The original OKM charger is not connected.</p> <p>Besides the detector, another device is connected to the OKM charger.</p> <p>The cable may be damaged.</p>	<p>Your device won't charge if the ambient temperature is below 14 °F (-10 °C) or higher than 140 °F (60 °C). Ensure a temperature between 50 and 77 °F (10 and 25 °C) and wait until possible condensation (moisture) has evaporated before you start charging or switch on the device.</p> <p>Make sure to use the original OKM charger.</p> <p>Make sure that you have plugged in only one device for charging. The OKM charger supplies a maximum of 65W. If a connected device already consumes the power limit, do not connect another device at the same time.</p> <p>Check the charging cable with another device to make sure it is working correctly, or try another standard USB-C cable.</p>
I have difficulties attaching the Super Sensor to the PentaSense Rod probe mount.	The probe is tilted in the probe mount.	<p>Try assembling the Super Sensor and the PentaSense Rod in a different way:</p> <ol style="list-style-type: none"> 1. Unfold the PentaSense Rod and secure the locking ring. 2. Place the rod vertically on its rear end in front of you. 3. Unlock the probe mount clips and insert the Super Sensor. Make sure the probe is oriented correctly – see 3.3 PentaSense Rod on page 14. 4. Close the probe mount clips. 5. Turn the PentaSense system the right way up.



The operating mode won't start and I see the following screen:



The probe is not connected properly.
The required probe is not connected.

Check the probe connection.
Plug in the PentaSense System – see [3.2 PentaSense System on page 13](#).

The operating mode won't start and I see the following screen:

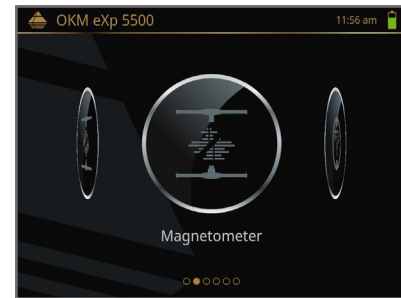

The probe is not connected properly.
The required probe is not connected.

Check the probe connection.
Plug in the PentaSense System – see [3.2 PentaSense System on page 13](#).

The operating mode won't start and I see the following screen:



The probe is not connected properly.
The required probe is not connected.

Check the probe connection.
Plug in the PentaCoil – see [3.5 PentaCoil + Telescopic Rod on page 15](#).

I get no signals between the Enhancers in Magnetometer mode.

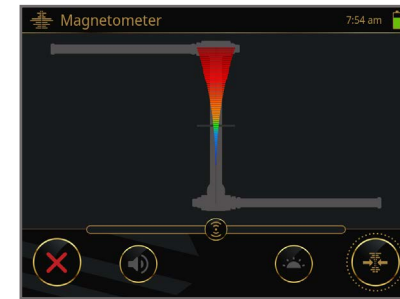

The Enhancers are not connected correctly.

The pair of sensors must be complete: Make sure that the Enhancers are connected in pairs (top and bottom) on the same side.

The graphs become unstable or are "frozen".

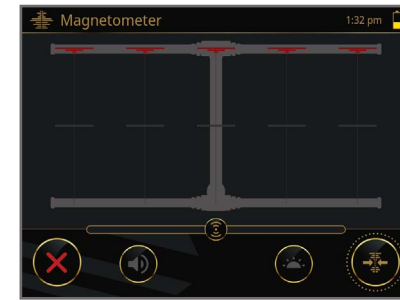

The soil conditions are not optimal (e.g. mineralization, contamination due to a lot of waste).

Place the probe above neutral ground (no objects underground) and tap on to perform a Ground Balance. The graphs will be reset to the zero line – see [5.4.3 Perform Measurement on page 27](#).

I don't hear any feedback sound in Magnetometer mode.

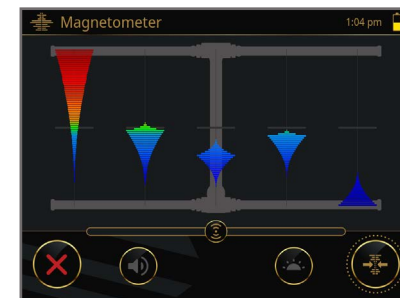

Sound is disabled.
Volume is too low.

Tap on the button to turn Sound ON (available at any time during scanning).
Increase the Magnetometer feedback volume in Settings > Sound. Move the third slider to adjust the volume individually. Move the fourth slider to adjust the general volume individually.

I don't see any LED Orbit feedback when using Magnetometer mode.

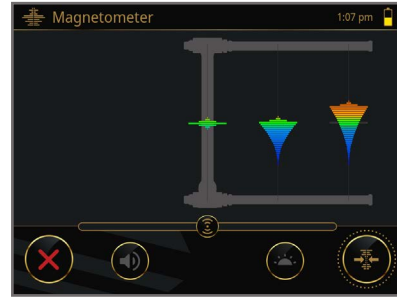

LED Orbit is disabled.

Tap on the button to turn LED Orbit ON (available at any time during scanning).

I don't hear any feedback sound in 3D Ground Scan mode.

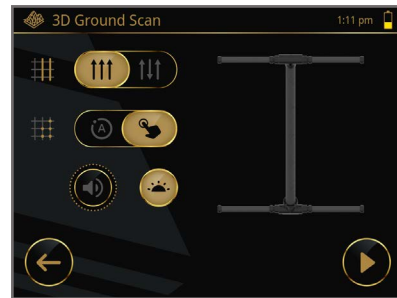

Sound is disabled.

Tap on the button to turn Sound ON. This option is only available in the 3D Ground Scan configuration screen.

Volume is too low.

Increase the 3D Ground Scan pulses volume in Settings > Sound. Move the first slider to adjust the volume individually. Move the fourth slider to adjust the general volume individually.

I don't hear any feedback sound in VLF Metal Detection mode.

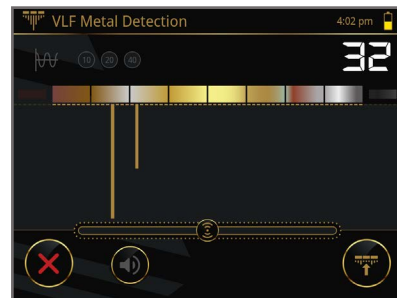

Sound is disabled.

Tap on the button to turn Sound ON (available at any time during scanning).

Volume is too low.

Increase the VLF Metal Detection feedback volume in Settings > Sound. Move the fourth slider to adjust the volume individually. Move the fourth slider to adjust the general volume individually.

I don't hear any feedback sound in VLF Metal Detection mode, but Sound is enabled.



The detected object results in a signal within the muted Target-ID zones.

Tap on the relevant Target-ID zone(s) to reactivate it and/or continue scanning until you receive signals in the activated Target-ID zone(s). For more details refer to [5.7.3 Measurement Screen on page 42](#).

Volume is too low.

Increase the VLF Metal Detection feedback volume in Settings > Sound. Move the fourth slider to adjust the volume individually. Move the fourth slider to adjust the general volume individually.

I can hardly see the Target-ID in the top right corner in VLF Metal Detection mode.



The detected object results in a signal within the grayed-out Target-ID zones.

Tap on the relevant Target-ID zone(s) to reactivate it and/or continue scanning until you receive signals in the activated Target-ID zone(s). For more details refer to [5.7.3 Measurement Screen on page 42](#).

When configuring the VLF Metal Detection, I see a red frame around the frequency options and a red warning icon instead of the start button.



No frequencies have been selected yet.

Select at least one frequency to proceed with the measurement. For more details refer to [5.7.1 Configure Measurement on page 40](#).

When configuring the VLF Metal Detection, I can not select further frequencies.

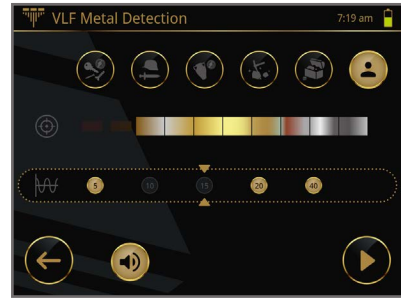

A maximum of 3 frequencies can be selected.

Select up to 3 frequencies. To select other frequencies, deactivate a previously selected frequency. For more details refer to [5.7.1 Configure Measurement on page 40](#).

During the VLF scan, I occasionally see a flashing red warning icon and hear a warning sound.

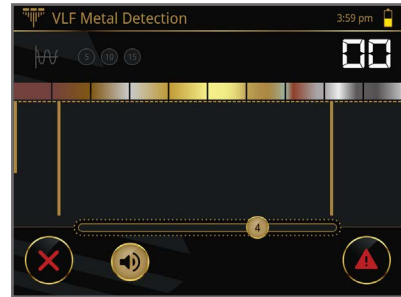

The signals became unstable due to changes in the soil conditions (e.g. mineralization, contamination due to a lot of waste).

Place the coil above neutral ground. Tap on to perform a Ground Balance – see [5.7.2 Perform Ground Balance on page 41](#). If no Ground Balance is performed, you will hear a warning sound every 10s (2x beep, if Sound is enabled).

The VLF Ground Balance failed.

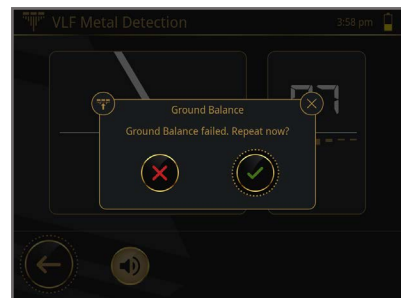

The PentaCoil has been moved during the Ground Balance process.

The soil conditions are not optimal (e.g. mineralization, contamination due to a lot of waste).

Hold the PentaCoil approx. 5cm | 2" above the soil surface and do not move it during the Ground Balance process.

Place the PentaCoil on neutral ground (no objects underground). Hold it approx. 5cm | 2" above the soil surface, do not move it and start the Ground Balance with .

When configuring the 3D Ground Scan, I see a red warning icon instead of the start button.

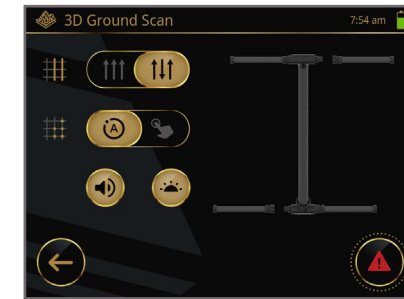

The Enhancers are not connected correctly.

The pair of sensors must be complete: Make sure that the Enhancers are connected in pairs (top and bottom) on the same side. For more details refer to [3.2.2 Enhancer Configurations on page 13](#).

I don't see the start button during the 3D Ground Scan.

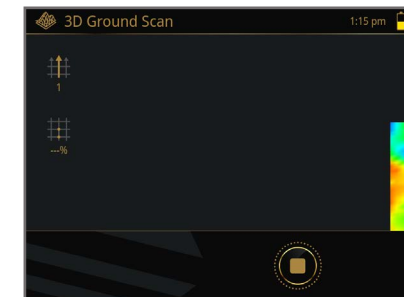

You are currently in the midst of the scan line in Automatic impulse mode.

The start button is only available after completing a scan line. Tap on it to start the next scan line.

I don't see the save button during the 3D Ground Scan.

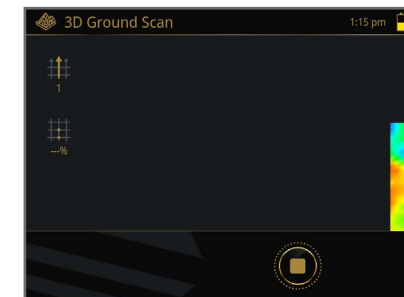

You are currently in the midst of the scan line. Too few lines have been scanned.

The save option is not available during the scan line. Finish the scan line. Measurements can only be saved after completing at least two scan lines.

DISPOSAL

8 DISPOSAL



Dispose the device or its components in accordance with local regulations.



RECYCLE USED PRODUCTS!
Reusing extends product life spans and contributes to the source reduction of raw materials.

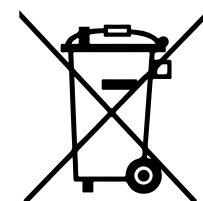

RECYCLE PROPERLY!
Do not put devices with integrated battery in the trash or municipal recycling bins.



CHOKING AND ASPHYXIATION HAZARD!
A Plastic Bag is Not a Toy!
Keep Away from Children!

TECHNICAL SPECIFICATIONS

9 TECHNICAL SPECIFICATIONS

Manufacturer	OKM GmbH
Type	Treasure Detector
Model	X55-A01

The technical specifications are medial values. Slight variations are possible during operation.

9.1 CONTROL UNIT

Dimensions [L x W x H]	75 x 210 x 230mm 3 x 8.3 x 9.1"
Weight	1.7kg 60oz
Battery	Li-ion, replaceable, 7.27V, 10.2Ah, 74.154Wh
Input	12V DC, 3A max
Output	6.4–8.4V DC, 15W max
Operating Time	7h @ 25°C 77°F, medium brightness
Charging Time	3h @ 10–30°C 50–86°F
Display	8.4" Diagonal, 1024 x 768 Pixel LVDS IPS-LCD
Processing Unit	Main (ARM Cortex 4x-A53@1.6GHz), Companions (1x M33@96MHz, 1x M4@48MHz, 1x M33@38MHz, 1x M7@216MHz)

Working Memory (RAM)	2GB
Data Memory (eMMC)	8GB
Operating Temperature	-10–50°C 14–122°F
Storage Temperature	-20–60°C -4–158°F
Air Humidity	5%–75%
Safety Class	IP40
Waterproof	No
Data Transmission	USB-C
Feedback	acoustic, visual
Audio	built-in Speakers Bluetooth-LowLatency (A2DP)

9.2 SUPER SENSOR

Dimensions [L x W x H]	1010 x 200 x 110mm 39.8 x 7.9 x 4.3"
Weight	0.74kg 26.1oz
Cable Length	70" 180cm
Input	6.4–8.4V DC, 4W
Safety Class	IP40
Receiver	Dual/Hi-Gain, Vertical, Geophysical Phase Reader, EMSR

Sensor Technology	SCMI-15-D
Processing Unit	ARM Cortex-M33 @ 38MHz

9.3 ENHANCER

Length	335mm 13.2"
Diameter	45mm 1.8"
Weight	0.1kg 3.5oz
Input	5.0V DC, 0.25W max
Safety Class	IP40
Sensor Technology	SCMI-15-D

9.4 PENTACOIL

Dimensions [L x W x H]	345 x 265 x 70mm 13.6 x 10.4 x 2.8"
Weight	0.84kg 29.6oz
Cable Length	180cm 70"
Input	6.4–8.4V DC, 2W max
Safety Class	IP40
Technology	VLF
Processing Unit	ARM Cortex-M7 @ 216MHz

9.5 PENTASENSE ROD

Dimensions, closed [L x W x H]	920 x 70 x 150mm 36 x 2.8 x 5.9"
Dimensions, opened [L x W x H]	1520 x 70 x 130mm 59.8 x 2.8 x 5.1"
Weight	2.76kg 97.4oz

10 REPS & WARRANTIES

To the extent applicable, the manufacturer OKM warrants that the Goods shall be free from material defects in workmanship and materials, so long as such Goods are used in conformance with their intended use and in strict compliance with the instructions of OKM, for a period of

- TWO (2) YEARS for new devices and demonstration devices,
- TWELVE (12) MONTHS for used devices,
- SIX (6) MONTHS for internal battery, Power Packs, chargers, and travel adapters,

the period shall start with the invoice date of said Goods to the Customer.

10.1 ACKNOWLEDGEMENTS, REPRESENTATIONS & WARRANTIES

THE WARRANTY SET FORTH IN THIS SECTION IS MADE IN LIEU OF ALL OTHER WARRANTIES (WHETHER EXPRESS OR IMPLIED), RIGHTS OR CONDITIONS, AND CUSTOMER ACKNOWLEDGES THAT EXCEPT FOR SUCH LIMITED WARRANTY, THE PRODUCTS ARE PROVIDED "AS IS." COMPANY SPECIFICALLY DISCLAIMS, WITHOUT LIMITATION, ALL OTHER WARRANTIES, EXPRESS OR IMPLIED, OF ANY KIND, INCLUDING, WITHOUT LIMITATION, THE IMPLIED WARRANTIES OF MERCHANTABILITY AND FITNESS FOR A PARTICULAR PURPOSE, NON-INFRINGEMENT, AND THOSE WARRANTIES ARISING FROM A COURSE OF PERFORMANCE, A COURSE OF DEALING OR TRADE USAGE.

The Customer represents and warrants, by entering into the Agreement and accepting the Services and/or Goods from OKM, that the Customer's execution, delivery, and performance of the Agreement has been duly authorized by all appropriate corporate action on the part of Customer, and the Agreement constitutes a valid and binding obligation of Customer enforceable against it in accordance with its terms.

The Customer agrees that he/she inspects the delivered Goods immediately upon receipt. If the Customer finds defects and/or experience technical problems, he/she agrees to contact the local dealer first (listed at www.okmdetectors.com/dealers). If the Customer cannot resolve the problem with the local dealer, the Customer will contact the manufacturer OKM:

OKM GmbH	Web: www.okmdetectors.com
Julius-Zinkeisen-Str. 7	Email: info@okmdetectors.com
04600 Altenburg	Phone: +49 3447 499 3000
Germany	WhatsApp/SMS: +49 162 419 2147

Defects must be claimed immediately in writing (at the latest 7 days after receipt) by using the OKM RMA Form provided at www.okmdetectors.com/rma and including the original proof of purchase (e.g. invoice).

Goods which are subject to complaints must be provided to the local dealer and/or to the manufacturer OKM for inspection. The Customer agrees to not send the Goods back without prior

consultation. The Customer must contact the local dealer and/or the manufacturer before returning the Goods.

Shipping costs (including fees, insurance etc.) to the local dealer and/or manufacturer are not covered by the dealer or manufacturer and are the responsibility of the customer.

10.2 INDEMNIFICATION

Filing a warranty claim does not automatically imply a refund. If a functional or material defect occurs and is claimed within the warranty period, the manufacturer OKM has the right to rectify the defect and provides the following warranty services at its own expense:

- rectification and repair of the defective device or component(s) **or**
- replacement of the defective component(s) **or**
- replacement with a new device.

After rectification or replacement, the return of the Goods from the manufacturer OKM to the Customer or assigned local dealer is covered by OKM and includes shipping insurance.

In cases in which the error cannot be eliminated, attempts at elimination are unreasonable or the elimination of the error has failed completely, the Customer may choose to

- request a reduction of the purchase price **or**
- withdraw from the contract and get the purchase price refunded.

For defects asserted within the warranty period but not eliminated, warranty is given until the defect is eliminated.

In the case of delivery of a new device, a new warranty period starts.

In the case of a warranty repair, the original warranty period and starting date applies to the Goods. A new warranty period applies only to the part replaced where such a replacement occurred.

10.3 LIMITATION OF LIABILITY

The Customer acknowledges that excluded from warranty are:

- poor performance due to improper use,
- signs of wear and tear,
- theft and/or loss of the device,

as well as defects and damages caused by:

- improper use and/or poor maintenance,
- defects created due to hitting and/or dropping the device,
- unauthorized alterations, repairs and/or modifications,

- abuse, misuse, deliberate destruction, accident,
- unusual physical and/or electric stress,
- exposure to moisture, water, extreme temperatures and/or fire,
- improper handling, transportation and/or storage,
- opening of any technical component and/or accessory.

If the device is defective but it is not a warranty case, refer to [6.5 Maintenance and Repair by OKM on page 48](#). If there is no warranty case, the costs for returning the device to the Customer are not covered and are not covered by the dealer or manufacturer.

OKM SHALL NOT BE LIABLE FOR AND DISCLAIMS ANY AND ALL LOST PROFITS AND ANY INDIRECT, INCIDENTAL, CONSEQUENTIAL, SPECIAL OR EXEMPLARY DAMAGES, WHETHER ARISING OUT OF THE SERVICES, THE GOODS, OR THE PERFORMANCE BY OKM UNDER THE AGREEMENT. IN THE EVENT OF TERMINATION FOR ANY REASON, OKM SHALL NOT BE LIABLE TO CUSTOMER FOR COMPENSATION, INDEMNIFICATION, REIMBURSEMENT OR DAMAGES ON ACCOUNT OF ANY LOSS OF PROSPECTIVE PROFITS OR ANTICIPATED SALES OR ON ACCOUNT OF EXPENDITURES, INVESTMENTS, LEASES OR COMMITMENTS MADE IN CONNECTION WITH THE AGREEMENT OR THE ANTICIPATION OF EXTENDED PERFORMANCE THEREUNDER. NOTWITHSTANDING THE FOREGOING, CUSTOMER'S EXCLUSIVE REMEDY AGAINST OKM, AND OKM'S SOLE OBLIGATION, FOR ANY AND ALL CLAIMS, WHETHER FOR BREACH OF CONTRACT, WARRANTY, TORT (INCLUDING NEGLIGENCE), OR OTHERWISE, SHALL BE LIMITED TO EITHER REPAIR OR REPLACEMENT OF THE NONCONFORMING GOODS OR REFUNDING THE AMOUNTS PAID BY CUSTOMER TO OKM DIRECTLY ATTRIBUTABLE TO NON-CONFORMING GOODS OR SERVICES. IN NO EVENT SHALL OKM HAVE ANY LIABILITY FOR DELAYS IN SHIPMENTS, SPECIAL, INCIDENTAL OR CONSEQUENTIAL DAMAGES, REGARDLESS OF WHETHER SUCH CLAIM IS BROUGHT IN TORT, BREACH OF CONTRACT, BREACH OF WARRANTY OR OTHER THEORY OF LAW OR EQUITY.

10.4 SERVICE & SUPPORT

Support during and after the warranty period is provided in all countries where the product is officially distributed by OKM. Refer to [6.5 Maintenance and Repair by OKM on page 48](#) and contact your local dealer and/or the manufacturer OKM for further information.

OKM DETECTORS

SUBSIDIARY
OKM Americas
Charlotte
USA

HEADQUARTERS
OKM GmbH
Julius-Zinkeisen-Str. 7
04600 Altenburg
Germany

SUBSIDIARY
OKM Türkiye
Antalya
Türkiye

SUBSIDIARY
OKM Emirates FZE
SAIF Zone, Sharjah
UAE

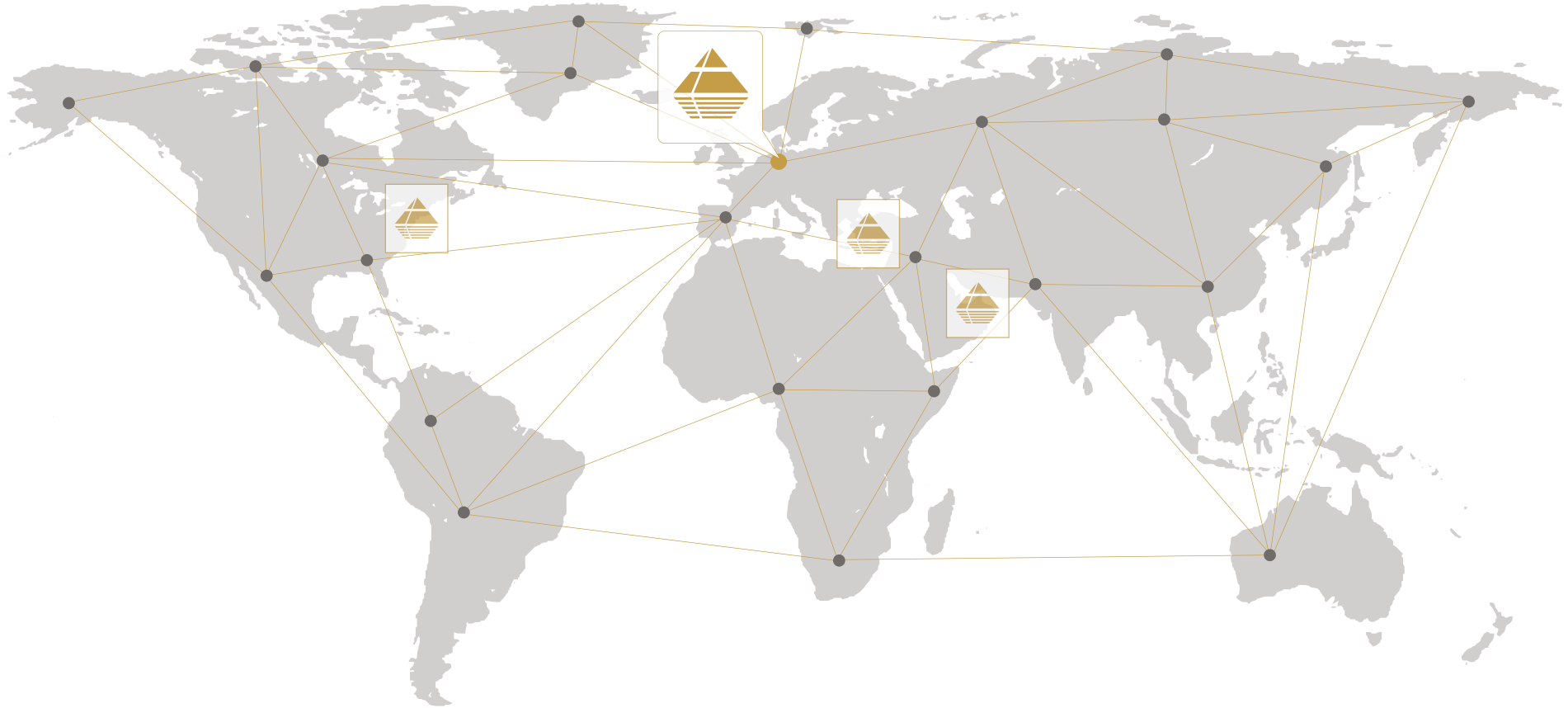

+49 3447 499 3000

+49 162 419 2147

info@okmdetectors.com

www.okmdetectors.com

